



SPEAR

A LANDMARK AQUATIC
COMPANY

**YOUR
WATER.
OUR
WORLD.**

WWW.SPEARCORP.COM



SPEAR

A LANDMARK AQUATIC COMPANY

From purchasing your test kit reagents to designing your swimming pool and much more, you can rely on the experience of Spear to provide everything you need to maintain your swimming pool and keep it clean and safe for swimming.

Family owned and operated since 1984.

Your Water. Our World.

info@spearcorp.com

800.642.6640

4
Chemicals

14
Test Kits / Reagents

18
Chemical Feed

30
Measurement Instruments

32
Filter / Strainer Parts

42
Safety

47
Lighting

48
Cleaning / Maintenance

50
Ladder Parts

52
Fittings

54
Valves

59
PVC

66
Paint & Patch

SANITIZERS / STABILIZER



**PB50
PULSAR PLUS DRY
BRIQUETTES**
50# Pail

65% calcium hypochlorite. For use in Pulsar® Feeders and are certified to NSF/ANSI Standard 50. While NSF certification is voluntary, over 30 states require aquatic chemical feeders to be certified or otherwise comply with the requirements of Standard 50.



**CH50
PULSAR GRANULAR**
50# Pail

Pulsar chlorinating granules - 68% calcium hypochlorite for multiple pool & spa uses - cyanuric acid free.



**PS25
PULSAR POWER
SHOCK**
25# Pail

The most powerful shock treatment available - Pulsar Power Shock 78% calcium hypochlorite granules activate in seconds to shock your pool and spa water.



**PI25
PULSAR INFINITY
TABLETS**
25# Pail

65% Available chlorine calcium hypochlorite. Non-Stabilized to use in Pulsar Infinity Feeders And are certified to NSF/ANSI standard 50.



**9004-50
BROMINE**
50# Pail

Bromine 1" tablets have 96% active bromine with a pH of 4. Alternative to chlorine sanitizers for pool & spa feeders.



**9002, 9002-5, 9002-15,
9002-55**

LIQUID CHLORINE BLEACH 1, 5, 15, 55 Gal
"Sodium Hypochlorite 12.5% Liquid Chlorine - Kills Bacteria - Controls Algae - Destroys Organic Contaminants - Shocks for Chloramine Removal. NSF option and additional sizes available.



**CA40
PULSAR SUNSCREEN STABILIZER**
40# Pail

Pulsar Sun Screen 20 is a high grade granular stabilizer used with sanitizer providing ultra violet protection for outdoor pools, protects available chlorine from UV degradation & reduces chlorine required during sunny conditions. Maintaining a level of 20 ppm of Pulsar Sun Screen 20 stabilizer will be most effective in minimizing chlorine usage but this is a case where more is not better.



**SB50
SODIUM BISULFATE**
50# Bag

Sodium Bisulfate is an acid in dry granular form used to lower pH and Total Alkalinity.



**SB50-P
SODIUM BISULFATE**
50# Pail

Sodium Bisulfate is an acid in dry granular form used to lower pH and Total Alkalinity.



**SA050
SODA ASH**
50# Pail

Soda Ash in powder form used to raise pH and Total Alkalinity.



**30557
PULSAR PH DOWN**
50# Pail

Pulsar pH Down in dry granular form used to lower pH and Total Alkalinity, for use in Pulsar Acid Feeder Plus unit.

PH BALANCE

ACID MAGIC



ASA128-1
1 Gallon



ASA5G-1
5 Gallon



ASA15G-1
15 Gallon



ASA55G-1
55 Gallon

Acid Magic is a full strength muriatic-based liquid product formulated to ship, use and store easier than standard muriatic acid. This revolutionary blend of proprietary ingredients offers cleaning & pH reduction of powerful acids while providing increased usability.

- Adjusts pool and spa water chemistry
- Extremely effective acid wash
- Cleans filters, chlorine generators and meter electrodes.

HYDROCHLORIC ACID

Hydrochloric (muriatic) Acid in liquid form used for lowering pH and total alkalinity



HC01
1 Gallon



HC15
15 Gallon



HC55
55 Gallon

WATER BALANCE / SHOCK TREATMENT / ALGAECIDES

CHEMICALS



CC50 PRESERVE
50# Pail
Calcium Chloride Preserve in dry flake form increases hardness



PU50 PUROLYTE
50# Pail
Purolyte non-chlorine shock in granular form designed to oxidize organic based contaminants in recreational water while the source (bathers) of contaminants is present. This forward approach to pool water management enhances water & air quality, thereby improving bather comfort and enjoyment. Purolyte is a non-halogen product to be used in tandem with the chlorine based sanitizer treatment.



ST55 DECHLOR
55# Pail
Sodium Thiosulphate Dechlor in crystal form reduces chlorine level after shock treatment.



SB05 BUFFER
50# Pail
Sodium bicarbonate buffer in powder form increases total alkalinity



PS25 PULSAR POWER SHOCK
25# Pail
The most powerful shock treatment available - Pulsar Power Shock 78% calcium hypochlorite granules activate in seconds to shock your pool and spa water.



HL25 HARBORLITE
25# Bag
This naturally occurring, environmental friendly, easy to handle Perlite filter media facilitates impressive water clarity by removing particle size down to 4.0 microns while at the same time absorbing oil from the water.



CE25 CELAPERL
25# Bag
This naturally occurring, environmental friendly, easy to handle Perlite filter media facilitates impressive water clarity by removing particle size down to 4.0 microns while at the same time absorbing oil from the water.



DE50 DIATOMATOUS EARTH
50# Bag
Filter powder for vacuum and pressure type DE filters.



FG50 FILTER GRAVEL
50# Bag
Filter gravel used as support media. Gravel size 1/8" x 1/4"



FS50 MYSTIC WHITE II
50# Bag
Mystic White II is the premium filter sand. The high quality, angular shape of Mystic White II sand maximizes the entrapment of solids. It filters out dirt, dust, leaves, insects, small stones, moss, oil, cosmetics, and other debris while minimizing packing, balling, and channeling in the filter bed.



VFA2550 VITROCLEAN GLASS
50# Bag
Vitroclean lasts 50% longer than typical silica sand and it does not clump or channel. Vitroclean can be installed in any standard sand media filter without the hazard of crystalline silica dust.



ACTIVATED FILTER MEDIA
10005 AFMng 55# Bag Grade 1
10006 AFMng 55# Bag Grade 2
10003 AFM 55# Bag Grade 3

Activated Filter Media is a direct replacement for sand, with 300 X more active surface area. It resists biofouling, iocoagulation and transient wormhole channeling of unfiltered water and never needs to be recharged or replaced

ALGIMYCIN 2000

In liquid form Algimycin 2000 algaecide kills, prevents and controls all algae types. A special wetting agent penetrates and kills even deeply-rooted algae cells. This nonmetallic, poly-complex formula gives fast effective control with no foaming or staining. It also acts as a clarifier and filter aid by removing algae fast. If used weekly, it prevents algae outbreaks in the pool. Fast and effective control of yellow, green & black algae.



A00Q
1 Quart

32091
Four 1 Gallon Per Case
AlgaeShield treats and prevents algae. It is compatible with all surface types and sanitization systems. It is effective on all types of algae. Treat just every 30 days.



CHEMICALS

FILTER CLEANERS / ENZYMES / METAL & SCALE



9037400166
BREAKAWAY FLUSH
1 Gallon

In liquid form Breakaway flush is specifically formulated to ensure that the unwanted build-up in your spa or hot tub is flushed out from the heart of your plumbing before you start-up. Breaks-up unseen deposits that build-up inside your spa's plumbing and heating systems, reducing water circulation, jet action and heating efficiency.



UF50
ULTRA FILTER CLEANER PLUS
50# Pail

In dry granular form this filter cleaner effectively removes grease, oil and scale from cartridge, DE and regenerative media filters. This filter cleaner produces oxygen during cleaning cycle so filter vessel vent valve must be open during cleaning to avoid pressure build-up and possible damage.



71006A
FILTER CLEANSE
2# Pail

In dry granular form this filter cleaner effectively removes scale, rust, hair, cosmetics, oils etc... which commonly reduce performance of sand, diatomite and cartridge filters. Filter cleaner has a color indicator that acts as a guide to proper application

ORB-3 POOL ENZYMES PRO



M411-000-5G
5 Gallon



M411-000-15G
15 Gallon

In liquid form this powerful, highly concentrated, economical, broad spectrum enzyme blend for larger commercial pools naturally removes body oils, lotions, cosmetics, urine and other organic materials which cause biofilms and scum lines in pools, surge pits, filters and plumbing.

AAD - AMINO ACID DIGESTER



NGWS-6
5 Gallon

AAD - Amino Acid Digester enzyme eliminates oxidant demands by digesting carbon based organic wastes in pool water by turning them into carbon dioxide, once removed your sanitizer will work more efficiently without harmful byproducts like chloramines.

MSI - METAL & SCALE INHIBITORS



MSIG-NGWS-1-M
1 Gallon



NGWS-2
5 Gallon

MSI - Metal & Scale Inhibitor - Start-up initial dose: 32 ounces per 10,000 gallons directly into circulation or maintenance dose 3 to 5 ounces per 10,000 gallons weekly depending on metal or calcium concentration.

CLEANER / DEFOAMER / PHOSPHATE REMOVER / CLARIFIER



TC00
TLC CLEANER
1 Quart

In liquid form TLC cleaner is formulated to remove oil, grime and mineral scale from common swimming pool surfaces such as tile, vinyl and concrete.



9019-1
PULSAR ACID CLEANER 50

In liquid form Pulsar Acid Cleaner 50 is a powerful lactic acid scale remover and used regularly prevents build-up of residue & scale. Does not contain muriatic acid so is much safer to use.



ULTRA SURFACE CLEANER

USC05 5 Gallon
USC15 15 Gallon
USC55 55 Gallon

Ultra Surface Cleaner is a liquid non-hazardous low pH organic compound for cleaning non-metallic pool and deck surfaces.



DEFOAMER

HQ 1 Quart
3639 1 Gallon

In liquid form this anti-foam agent works effectively at cutting down foam and preventing foam build-up in spas.

NCF3
PHOSFREE
3 Liter



PhosFree is a cost effective way to convert soluble phosphates to insoluble lanthanum phosphates that can then be removed by filtration then allowing normal sanitizer levels to prevent algae growth. Add product directly to skimmer.

NGWS-10 CPR - CONCENTRATED PHOSPHATE REMOVER

1 Gallon



Crystalizes orthophosphates in the water to drop them out for removal by filtration and backwash.



9007
CLARIFIER
1 Quart

A liquid organic polymer to polish the water, helping filter remove suspended particles that cause dull, cloudy water.



30497
CLAIRIFIER PRO
5 Gallon



SAOQ
SEQUESTERING AGENT
1 Quart

In liquid form controls minerals, prevents stains, scale and rust. Use for initial fill and for weekly maintenance.



WYSI
WYSIWASH CLEANING SOLUTION
5.9 Ounces

A Pail of Wysiwash Cleaning solution contains 9 jacketed caplets that kill germs, algae, mold, and dangerous pathogens. With proper drainage and storage, one caplet is good for up to 3.5 hours of continuous cleaning. The 9 count pail is equivalent to approximately 45 gallons of bleach.



CIT01
CITRISURF 77 PLUS
22 Ounces

CitriSurf 77 Plus is a high quality blend of chemicals formulated for cleaning, rust removal and passivation of stainless steel products. Provided in spray bottle for applications where it is desired to spray the product on a local area. CitriSurf 77 Plus is specifically designed to provide a portable, low cost and efficient removal of contaminants, rust and free iron from stainless steel surfaces, providing the highest chrome oxide levels possible.



CIT00
CITRISURF
22 Ounces

CitriSurf 77 is a high quality blend of chemicals formulated for the cleaning and passivation of stainless steel products. It is provided in trigger sprayer bottles for applications where it is desired to spray the product on a local area. CitriSurf 77 Plus is specifically designed to provide a portable, low cost and efficient removal of contaminants and all free iron from the surface of stainless steel, providing the highest chrome oxide levels possible.

REVIVE PRO



CHF-50-314
32 Ounce



CHF-50-320
1 Gallon



CHF-50-635
5 Gallon



CHF-50-316
30 Gallon

Revive Pro naturally restores water quality by removing orthophosphates up to 2000 ppb, removing copper and iron up to 2.0 ppm, captures scaling carbonates and clears water of organic debris.



WYS-102
SPRAY GUN



4299-8
PUMP PROTECTOR
10 Ounces

Foam-in shut down corrosion protection for all types of pumps. Any pump that is shut down and drained part of the time should be safeguarded with aerosol Pump Protector. Pumps used in cooling towers, swimming pools and vacation homes, auxiliary pumps, marine and industrial pumps can develop corrosion deposits on the impeller and other close-tolerance areas during shut down, causing the pump to bind. Aerosol Pump Protector prevents this corrosion and lubricates the pump so that it starts right up every time! Pump Protector is water soluble and will not cause any foaming problem when the pump is started. If the pump is used for drinking water, flush it thoroughly by running water off a few minutes before placing the pump back in service.



47906
SPECTRA-CLEAN SYSTEM 1
22 Ounces

Spectra-Clean System 1 is used as a maintenance solution for use in a scheduled operations plan. Other customers have set up where they clean and passivate the stainless quarterly or on some other applicable schedule. Spectra Clean system 1 will also address minor tea staining corrosion.



47904
SPECTRA-CLEAN SYSTEM 3
1 Gallon

Spectra Clean System 3 is only used in the most extreme of situations. In most of these situations the corrosion has caused irreversible damage to the product and the cause of the corrosion should be further addressed.



47905
SPECTRA-CLEAN SYSTEM 2
1 Gallon

Spectra-Clean System 2 is generally used in cases of more excessive corrosion. The most common application would be a restoration rather than preventative situation. If the corrosion is so excessive that pitting has begun to occur it is recommended to upgrade to the Spectra Clean system 3.



57373
SPECTRA-SHIELD STAINLESS STEEL PROTECTANT
1 Gallon

As an extra layer of protection Spectra-Shield may be applied for maximum corrosion protection once cleaning and passivation has been completed. Comes in one gallon jug.

MAINTENANCE YOU CAN FORGET ABOUT



INTRODUCING:

The **Pulsar® Precision 30**. Space saving design with the same consistent chlorine delivery.

New patent pending diffuser improves agitation of solids with solid removal, improving the time between maintenance





LMPXUS LUMISO POOLTEST EXPERT

The Lumiso Pooltest has been designed for a range of pool and spa customers from pool managers to professional engineers who need to test pool and spa water multiple times daily, quickly, and accurately across key trouble shooting parameters.



LMP106 LUMISO POOLTEST 6

The brand new Lumiso Pooltest 6 enables a complete water balance calculation, with tests for alkalinity, bromine, calcium hardness, chlorine, cyanuric acid and pH.



LMP103 LUMISO POOLTEST 3

The brand new Lumiso Pooltest 3 combines testing for chlorine, pH and cyanuric acid, for reliable assessments of water quality.



PT153T POCKET SENSOR

TDS Pocket Sensor 0-200ppm, 0-2000ppm, 1-10ppt - Automatic standard recognition for straight forward calibration, Automatic temperature compensation and temperature displayed on screen, Waterproof to IP67 to protect the instrument in all environments.



3582 LAMOTTE MOBILE WATERLINK SPIN TOUCH

The innovative Lamotte mobile WaterLink® Spin Touch™ photometer does all your pool and spa water testing for you wherever you need it! Each sealed reagent disk contains the precise amount of reagent needed to run a complete series of tests in just 30 or 60 seconds. Simply fill a reagent disk with a water sample, place it in the meter, tap, start, and all your vital tests are done automatically. Comes complete with photometer, instruction manual, quick start guide, 3-syringes, meter check disk, USB cord, USB wall adapter and upright waterproof carrying case with foam insert.



7001-NJ-01 LAMOTTE PRO 250 SERIES

Every PRO250 SERIES kit includes color-coded caps to prevent mixups, and diagrammed instructions make testing a breeze.

Product Name	Description	Part #	LMP003	LMPXUS	LMP006	PoolTest10	PoolTest 25
DPD #3	250 TESTS	AP031/1	0-5	X	0-5	X	X
DPD XT	250 TESTS	AP033/1	0-10	X	0-10	X	X
CHLORINE FREE, DPD 1	250 TESTS	AP011	0-5	X	0-5	X	X
DPD-XF CHLORINE FREE-EXTENDED	250 TESTS	AP013	0-10	X	0-10	X	X
CHLORINE FREE, COMB & TOTAL	250 TESTS	AP031	0-5	X	0-5	X	X
DPD XF & XT CHLORINE FREE & CYANURIC ACID	250 TESTS	AP033	0-10	X	0-10	X	X
PH PHENOL RED	250 TESTS	AP087	X	X	X	X	X
TOTAL ALKALINITY, ALKAPHOT	250 TESTS	AP130	X	X	X	X	X
CALCIUM HARDNESS	250 TESTS	AP188		X	X	X	X
ROUND TEST TUBES 10 ML	PK/5	AP252		X	X	X	X
ROUND TEST TUBES 10 ML	PK/5	PT595/5				X	X
CRUSH, STIRRING RODS		PT555	X	X	X		
BROMINE	250 TESTS	PT502	X	X	X	X	X
AMMONIA	250 TESTS	AP060		X	X	X	X
SULPHATE	250 TESTS	AP152		X			X
IRON LR	0.01-1	AP154		X		X	X
CHLORINE HR	1-250	AP155		X			X
PHOSPHATE LR	0.03-4.0 200 TESTS	AP162		X		X	X
COPPER, COPPERCOL - FREE,	250 TESTS	AP177		X		X	X
COPPER, FREE	250 TESTS	AP186		X		X	X
HARDNESS, HARDICOL	250 TESTS	AP187		X		X	X
CHLORIDE, CHLORIDOL	250 TESTS	AP254		X			X
PHMB	250 TESTS	AP268		X			X
		AP272					X

Product Name	Description	SKU- Part Number	Lamotte Pro 250 SERIES / 7001-NJ-01	Lamotte Waterlink Spin Touch Model 3582	Not in Kits
DPD 1A Free Chlorine	30 mL	P-6740-G	X	X	
DPD 1B Free Chlorine	30 mL	P-6741-G	X	X	
DPD 3 Total Chlorine	30 mL	P-6743-G	X	X	
Cyanuric Acid	250 mL	WL-4856-K		X	
pH Indicator	60 mL	P-7026-H	X		
Hard I	60 mL	P-4259-H	X		
Hard Titrant	60 mL	P-7031-H	X		
DPD Chlorine 1A	60 mL	P-6740-H	X		
DPD Chlorine 1B	60 mL	P-6741-H	X		
DPD Chlorine 3	60 mL	P-6743-H	X		
Alk Titrant	60 mL	P-6111-H	X		
pH for Color Q Kit	30 mL	7037-G			X
Alkalinity for Color Q	30 mL	7038-G			X
Calcium Hardness 1 for Color	30 mL	7042-G			X
Calcium Hardness 2 for Color	30 mL	7041-G			X
pH Indicator	60 mL	WL-7027-H		X	
Alk Titrant	60 mL	WL-4493-H		X	
Hardness Titrant	50 mL	WL-4487-H		X	
Base Reagent	60 mL	WL-6460-H		X	
Iron 1 Reagent	60 mL	WL-4450-H		X	
pH Indicator	25 mL	P-7026-G	X		
Base Demand	30 mL	P-6460-G	X		
Alk Indicator	30 mL	P-7028-G	X		
Hard 2 Indicator	30 mL	P-7030-G	X		
Acid Demand	30 mL	P-6068-G	X		
Hardness 1	15 mL	WL-4259-E		X	
Acid Demand	15 mL	P-6068-E	X		
MPS Out	15 mL	6910-E			X
Iron 2 Powder	10 GM	WL-4451-D		X	
Copper Tablets	(100)	WL-3808-J		X	
Alk 1 Tablets	(100)	WL-T-2311-J		X	
Hardness 2 Tablets	(100)	WL-T-5250-J		X	
Colorimeter Tubes	Set of 6 with caps	0967-6		X	
Water sample bottle	2 oz	0688		X	
Test tube	5 mL	0644		X	
Test tube	5.2 mL	0645		X	
Syringe	5 mL	0807		X	
Direct Reading Titrator	Syringe, 0-500 range	0383		X	
Direct Reading Titrator	Syringe, 0-200 range	0382		X	
4329-H Disk	Single Use Ten Parameter	50 disks		X	
4334-H Disk	Three Use Three Parameter	50 disks		X	
1768 Waterlink DataMate Software	V.10.0 - See minimum software required			X	



**K-2000
TAYLOR 2000 STARTER**

Basic kit with .75 ounce liquid reagents for testing free available, total and combined chlorine, bromine, pH, acid and base demand. Comes in hard case with visual comparator and includes waterproof instruction guide.



**K-2006
2006 COMPLETE**

FAS-DPD Chlorine test kit with .75 ounce liquid reagents is same as K-2005 except utilizes 9058 comparator and comes with 10 grams of DPD powder for sanitizer tests by titration method, offering better accuracy and less color matching error. Comes in hard case with visual comparator and includes waterproof instruction guide.



**K-2005
2005 COMPLETE**

High range test kit with .75 ounce liquid reagents for testing free available, total and combined chlorine, bromine, pH, acid and base demand, total alkalinity, calcium hardness and cyanuric acid. Comes in hard case with visual comparator and includes waterproof instruction guide.



**K-2005C
SERVICE COMPLETE**

Same as K-2005 except larger 2 ounce reagents



**K-2006C
K-2006C SERVICE COMPLETE**

Same as K-2006 except larger 2 ounce reagents and more DPD powder.



**K-1518
DROP TEST,
CHLORINE**

Chlorine, Free & Combined/ Monopersulfate FAS-DPD



**1749
PROBE TESTER**

The electronic Salt TRACER PockeTester? measures the Sodium Chloride level in salt water pools with a range from 0 to 9,999 ppm. TDS is measured from 0 to 9,999 ppm and Temperature from 32.0° to 149°F.

Product Name	Main Description	Part #	K-1518	K-2000	K-2005	K-2005C	K-2006	K-2006C	Not in Kits
DPD Reagent #1	.75 oz, Dropper Bottle	R-0001-A		X	X				
DPD Reagent #1	2 oz, Dropper Bottle	R-0001-C							X
DPD Reagent #2	.75 oz, Dropper Bottle	R-0002-A		X	X				
DPD Reagent #2	2 oz, Dropper Bottle	R-0002-C							X
DPD Reagent #3	.75 oz, Dropper Bottle	R-0003-A		X	X		X		
DPD Reagent #3	2 oz, Dropper Bottle	R-0003-C	X			X			X
pH Indicator Solution (for 2000 Series)	Phenol Red, .75 oz, Dropper	R-0004-A		X	X		X		
pH Indicator Solution (for 2000 Series)	Phenol Red, 2 oz, Dropper	R-0004-C				X			X
Acid Demand Reagent (for 2000 Series)	.75 oz, Dropper Bottle	R-0005-A		X	X		X		
Acid Demand Reagent (for 2000 Series)	2 oz, Dropper Bottle	R-0005-C				X			X
Base Demand Reagent (for 2000 Series)	.75 oz, Dropper Bottle	R-0006-A		X	X		X		
Thiosulfate N/10	.75 oz, Dropper Bottle	R-0007-A			X		X		
Thiosulfate N/10	2 oz, Dropper Bottle	R-0007-C				X			X
Total Alkalinity Indicator	.75 oz, Dropper Bottle	R-0008-A			X		X		
Total Alkalinity Indicator	2 oz, Dropper Bottle	R-0008-C				X			X
Sulfuric Acid .12N	.75 oz, Dropper Bottle	R-0009-A			X		X		
Sulfuric Acid .12N	2 oz, Dropper Bottle	R-0009-C				X			X
Calcium Buffer	.75 oz, Dropper Bottle	R-0010-A			X		X		
Calcium Buffer	2 oz, Dropper Bottle	R-0010-C				X			X
Calcium Indicator Liquid	.75 oz, Dropper Bottle	R-0011L-A			X		X		
Calcium Indicator Liquid	2 oz, Dropper Bottle	R-0011L-C				X			X
Hardness Reagent	.75 oz, Dropper Bottle	R-0012-A			X		X		
Hardness Reagent	2 oz, Dropper Bottle	R-0012-C				X			X
Cyanuric Acid Reagent	.75 oz, Dispenser Tip	R-0013-A			X		X		
Cyanuric Acid Reagent	2 oz, Dispenser Tip	R-0013-C				X			X
pH Indicator Solution (Residential Series)	Phenol Red, .75 oz, Dropper	R-0014-A							X
Acid Demand Reagent (Residential Series)	.75 oz, Dropper Bottle	R-0015-A							X
Total Alkalinity Indicator	2 oz, Dropper Bottle	R-0645-C							X
Sodium Thiosulfate	2 oz, Dropper Bottle	R-0747-C							X
TDS Resin	50 g	R-0809-II							X
Sodium Carbonate	.24N, 2 oz, Dropper Bottle	R-0810-C							X
Deox Reagent	2 oz	R-0867-C	X						
Deox Reagent	2 oz	R-0867-C							X
DPD Powder	10 g	R-0870-I	X				X	X	
FAS-DPD Titrating Reagent (for chlorine)	.75 oz, Dropper Bottle	R-0871-A					X		
FAS-DPD Titrating Reagent (for chlorine)	2 oz, Dropper Bottle	R-0871-C	X						X
FAS-DPD Titrating (for bromine)	.75 oz, Dropper Bottle	R-0872-A							X
FAS-DPD Titrating (for bromine)	2 oz, Dropper Bottle	R-0872-C							X
pH Indicator Solution	Phenol Red, .75 oz	R-1003J-A							X
pH Indicator Solution	Phenol Red, 2 oz	R-1003J-C							X

BECS PARTS

BECSYS PH SENSOR



9660013
pH Sensor, 36" cable

9660010
pH Sensor, 120" cable

BECSYS ORP SENSOR



9660022
ORP Sensor, 36" cable

9660023
ORP Sensor, 120" cable

BECSYS TEMP SENSOR

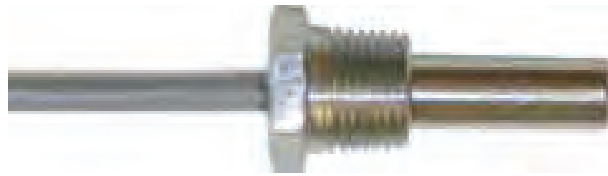

8660016
Temperature
Sensor, 30" cable

9660003
Temperature
Sensor, 120"

8660096 BECSYS FREE CHLORINE SENSOR WITHOUT FLOW CELL ASSEMBLY



8680096 BECSYS REPLACEMENT MEMBRANE CAP



8680095 BECSYS ELECTROLYTE FOR PPM SENSOR 100 ML



CP1 CHLORINE SENSORS



2210422 - CP1 Chlorine Sensor LH (CCW) Counter Clockwise for use with lighted flow cell, includes beads and O-Ring.

2210457 - CP1 Chlorine Sensor RH (CW) Clockwise for use with CCF2 flow cell, includes beads and O-Rings.

2100419 ROTARY FLOW SWITCH



2210444 CLEANING BEADS



8680016 REPLACEMENT MEMBRANE



Replacement
Membrane for Free
Chlorine Sensor

8680056 ELECTROLYTE SOLUTION



TANKS

SB-K70 SODIUM BISULFATE TANK KIT



This 70 gallon dual containment tank is fitted with a drop tube for your pump suction line, a timer for your pump, and included 1/20th HP mixer motor with stainless steel epoxy coated propeller shaft.

SB-K120 SODIUM BISULFATE TANK KIT



This 120 gallon dual containment tank is fitted with a drop tube for your pump suction line, a timer for your pump, and included 1/20th HP mixer motor with stainless steel epoxy coated propeller shaft.

01-29828 GEMINI SQUARE



70 Gallon Vertical Square Dual Containment tank - SD - Natural, 24" x 24" x 41"

01-1072 GEMINI CYLINDRICAL



120 Gallon Vertical Dual Containment tank - SD - Natural, 33" diameter x 47" height

Additional tank sizes, mixers, & parts available. Please contact customer service for assistance.

MIXERS

LDB-0050-PRP/EK-34 JL WINGERT MIXER



JL Wingert 1/20 HP Mixer 1550 RPM, 115 VAC with fully Adjustable Steel Bracket Mount comes with 5/16 Inch x 34 Inch Stainless Steel Epoxy Coated Shaft and Propeller.

6023-120V TIMER



Set & Go Timer 120 VAC, 60 minutes

0280/EK PROPELLER SHAFT



34" Epoxy Coated Propeller Shaft 5/16" Diameter use with LDB-0050-PRP/EK-34 Mixer

CHEMICAL METERING PUMPS

PD761-848SI LMI



Phase:1 PH
Volt: 115VAC
PSI: 70
GPH: 2
Suction: 3/8
Discharge: 3/8
Weight: 11LBS

B131-362SI LMI



Phase:1 PH
Volt: 115VAC
PSI: 50
GPH: 4.5
Suction: 3/8
Discharge: 3/8
Weight: 15LBS

45MJL5A3STAA STENNER



Model: 45M5
Phase:1 PH
Volt: 115 VAC
PSI: 25
GPH: 0.10 - 2.08
Suction: 3/8
Discharge: 3/8
Weight: 9 LBS

85MJL5A3STAA STENNER



Model: 85M5
Phase:1 PH
Volt: 115 VAC
PSI: 25
GPH: 0.18 - 3.54
Suction: 3/8
Discharge: 3/8
Weight: 9 LBS

A1N30A-7T1 BLUE-WHITE



Model: A-100NA
Phase:1 PH
Volt: 115 VAC
PSI: 50
GPH: 3.96
Suction: 3/8
Discharge: 3/8
Weight: 10LBS

A1A4-7T BLUE-WHITE



Model: A1A Series
Volt: 120 VAC
PSI: 40
GPD: 100

FlexFlo Peristaltic
Metering Pump for
commercial aquatics



STENNER ECON T

E10T1A81S8

Name Type: Stenner
Econ T
Phase:1
Volt: 120
PSI: 25
GPH: 0.10
Suction: 1/4 Inch
Discharge: 1/4 Inch
Weight: 5 LBS

E10T2C81S8

Name Type: Stenner
Econ T
Phase:1
Volt: 120
PSI: 25
GPH: 0.63
Suction: 1/4 Inch
Discharge: 1/4 Inch
Weight: 5 LBS

BOOSTER PUMPS / TUBING



011641 WHISPERFLO

Phase: 3
Volt: 208-230/460
HP: 1
FLA: 4.9-4.5/2.3
Suction: 2 Inch
Discharge: 2 Inch
Weight: 41
SF: 1.65



015583 WHISPERFLO

Phase:1
Volt: 115/208-230
HP: 1.1
FLA: 10.5/5.4-5.4
Suction: 2 Inch
Discharge: 2 Inch
Weight: 50
SF: 1.00



205955 PULSAR BOOSTER

Phase:1
Volt: 115/230 VAC
FLA: 12.6 / 6.3
Suction: 2 Inch
Discharge: 2 Inch
Weight: 36
SF: 1.25

BLACK & WHITE POLY TUBING



PART NUMBER	DESCRIPTION
SC1000	1/4" O.D. White Poly Tubing
SC1001	3/8" O.D. White Poly Tubing
SC1002	1/2" O.D. White Poly Tubing
SC1003	5/8" O.D. White Poly Tubing
01700250040111300100	1/4" O.D. Black Poly Tubing
75062111300100	3/8" O.D. Black Poly Tubing
00062111300100	1/2" O.D. Black Poly Tubing
25062111300100	5/8" O.D. Black Poly Tubing

LMI PARTS

MFV- MULTI FUNCTION VALVES



FOOT VALVES



INJECTION VALVES



HEAD ASSEMBLY



REPAIR KITS



RPM PRO PACS



PART #	TYPE	DESCRIPTION
34626	4 Function Valve	LE 26S, 36S
77383	Connection Kit	Tubbing Connection Kit
77382	Connection Kit	Tubbing Connection Kit 1/4"
77384	Connection Kit	Tubbing Connection Kit 1/2"
48728	Injection Check Valve	Injection Check Valve
48721	Foot Valve	
57706	Multi-Function Valve	Retro Fit Kit
SP-U2	Repair Kit	LE75S, 75T
SP-U6	Repair Kit	LE 30, 30S,32, 34, 35P, 35T, 36, 36S
SP-U7	Repair Kit	LE 190,190S, 191, 191S, 192, 192S, 193, 193S, 198, 198S
SP-U8	Repair Kit	LE 150, 150S, 151, 151P, 151S, 152, 152S, 158
SP-U9	Repair Kit	LE 155, 155P, 155S
SP-26	Repair Kit	LE 26, 26S
RPM-392/398	RPM Pro Pac	LE 392XX, 398XX, 490XX, 498XX
RPM-362/368	RPM Pro Pac	LE 362XX, 368XX, 460XX, 468XX
RPM-929	RPM Pro Pac	LE 929XX
RPM-832	RPM Pro Pac	LE 832XX, 838XX, 930NX, 930SX
RPM-822	RPM Pro Pac	LE 822XX, 828XX, 920NX, 920SX
RPM-738	RPM Pro Pac	LE 738XX

STENNER SANTOPRENE PUMP TUBES



BLUE-WHITE NORPRENE PUMP TUBES



Older pumps not already retrofitted require retrofit kit #72000-550.

AK700 STENNER FLOW INDICATOR W/BRACKET 3/8"



CHEMICAL PUMP PARTS

PART #	TYPE	DESCRIPTION
MCCP201	Stenner Santoprene	#1 - Five Pack
MCCP202	Stenner Santoprene	#2 - Five Pack
MCCP203	Stenner Santoprene	#3 - Five Pack
MCCP204	Stenner Santoprene	#4 - Five Pack
MCCP205	Stenner Santoprene	#5 - Five Pack
MCCP207	Stenner Santoprene	#7 - Five Pack
UCCP201	Stenner Santoprene	#1 - Two Pack
UCCP202	Stenner Santoprene	#2 - Two Pack
UCCP203	Stenner Santoprene	#3 - Two Pack
UCCP204	Stenner Santoprene	#4 - Two Pack
UCCP205	Stenner Santoprene	#5 - Two Pack
UCCP207	Stenner Santoprene	#7 - Two Pack
A1-4T	Blue-White Norprene	Tube Assembly A-100N (-4T) 1/4" OD 3/8" OD Tube Compression Fitting
A1-6T	Blue-White Norprene	Tube Assembly A-100N (-6T) 3/8" OD 3/8" OD Tube Compression Fitting
A1-7T	Blue-White Norprene	Tube Assembly A-100N (-7T) 7/16" OD 3/8" OD Tube Compression Fitting

Additional parts available. Please contact parts department for assistance.

PULSAR PARTS

PULSAR PARTS

CHEMICAL FEED

CHEMICAL FEED



71811
1-1/2" VENTURI



PLSR12FNCV050
1/2" FPT LARGE LINE
STRAINER ASSEMBLY



PLSS12MNCV050
1/2" MPT SMALL LINE
STRAINER ASSEMBLY



205488
DEFLECTION PLATE
205446 - P-3



205894
DISCHARGE VALVE
LOCKING TOOL



206079
DISCHARGE VALVE:
ARM



205958
DISCHARGE VALVE:
ASSEMBLY WITH
CHECK VALVE



205491
1/2" MXF BALL VALVE



205489
1/2" MXM BALL
VALVE



71923
24V AC TRANSFORMER/
PLUG IN



212657
BRACKET LID SWITCH



206078
DISCHARGE VALVE:
ASSEMBLY WITH
CHECK VALVE



206080
DISCHARGE VALVE:
BODY



206082
DISCHARGE VALVE:
FLOAT



938034
DISCHARGE VALVE:
LOCK NUT



AF12-30-10-11
ABB CONTACTOR



205478
BRIQUETTE SCREEN
ASSEMBLY
205446 - P-3

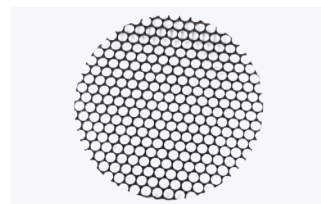

212640
BRIQUETTE SCREEN
ASSEMBLY
205566 - P-45

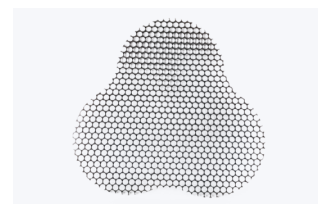

212646
BRIQUETTE SCREEN
ASSEMBLY
205567 - P-140



205606
DISSOLVING CUP W/
NOZZLE ASSEMBLY
206077 - P-1



938046
ELECTRONIC RELAY
5007 - P-4



205527
ELECTRONIC SHUT
OFF
5007 - P-4

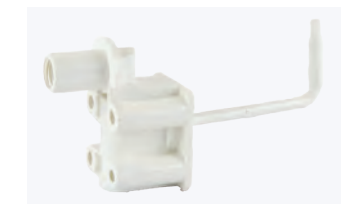

205450
EMERGENCY SHUT
OFF VALVE - ARM
ONLY

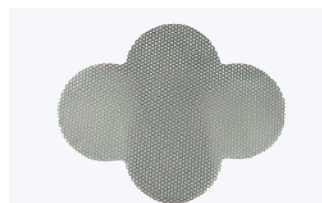

212653
BRIQUETTE SCREEN
ASSEMBLY
205568 - P-500

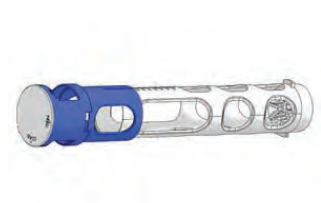

226405
CARTRIDGE
ASSEMBLY
226392 - Infinity



205959
CHECK VALVE



205442
EMERGENCY SHUT
OFF VALVE ASSEMBLY



205452
EMERGENCY SHUT
OFF VALVE: 1/4"
SCREWS 4PK



205454
EMERGENCY SHUT
OFF VALVE: FLOAT



5900045
EMERGENCY SHUT
OFF VALVE: FLOAT
PLATE

PULSAR PARTS



205451
EMERGENCY SHUT OFF VALVE: MOUNTING PLATE



71538
EMERGENCY SHUT OFF VALVE: PVC NUT



205540
EMERGENCY SHUT OFF VALVE: RUBBER GASKET



205591
ENHANCEMENT ADAPTER
205446 - P-3



205592
ENHANCEMENT KIT
205446 - P-3



79698
FEED SPRAY NOZZLE
206077 - P-1



71617
FEED SPRAY NOZZLE



71888
FEED SPRAY NOZZLE



205604
FLOW INDICATOR
206077 - P-1



155480
FLOW INDICATOR



155872
FLOW INDICATOR REPAIR KIT



938033
GASKET FOR DISCHARGE VALVE



205610
GRID
206077 - P-1



205441
GRID (LOW/MED/HIGH)
206077 - P-1



205886
GRID (LOW/HIGH)
206077 - P-1



205957
GRID CAP



71373
GRID CLEANING PAN



206084
LINE STRAINER ASSEMBLY



226913
PLUG
226392 - Infinity



216423
SAFETY OVERFLOW SWITCH



206041
SAFETY SWITCH FOR LID



205472
SCOOP



71880
SHUT OFF ASSEMBLY
5007 - P-4



226792
SOLENOID VALVE
226392 - Infinity



233303
GRID BASKET



226402
NOZZLE



250951
EMERGENCY SHUT OFF VALVE



233308
BOWL



251185
REPLACEMENT LID

PULSAR PARTS



**8212A519S0100F1
SOLENOID VALVE**



**206036
SPRAY KIT**
206077 - P-1



**205928
SPRAY MANIFOLD**
205446 - P-3

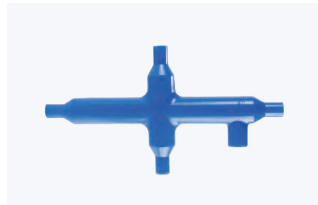

**205519
SPRAY TREE**
5007 - P-4



**226797
TRANSFORMER**
226392 - Infinity



**RK4.4T10RS4.4T
TURCK CABLE**



**RKC8T-10-RSC8T
TURCK CABLE
EXTENSION**



**71901
WASH DOWN SPRAY
NOZZLE**
5007 - P-4



**72861
WASH DOWN SPRAY
NOZZLE**
205446 - P-3



**72862
WASH DOWN SPRAY
NOZZLE**
205446 - P-3



**938049
WASHER FOR
DISCHARGE VALVE
ADAPTER**
205446 - P-3



**205885
WAVE DISSOLVING
CUP**
206077 - P-1



**205890
WAVE LID FLAP**
206077 - P-1

SOLENOID VALVES



HARDWIRE CONNECTION
Asco Solenoid - Slow Closing With Hardwire Connection

Part No.	Description
8221G001 24/60	3/8", 24/60
8221G001 120/60	3/8", 120/60
8221G003 24/60	1/2", 24/60
8221G003 120/60	1/2", 120/60
8221G005 24/60	3/4", 24/60
8221G005 120/60	3/4", 120/60
8221G007 24/60	1", 24/60
8221G007 120/60	1", 120/60



DIN CONNECTION
Asco Solenoid - Slow Closing With DIN Connection

Part No.	Description
SC8221G001 24/60	3/8", 24/60
SC8221G001 120/60	3/8", 120/60
SC8221G003 24/60	1/2", 24/60
SC8221G003 120/60	1/2", 120/60
SC8221G005 24/60	3/4", 24/60
SC8221G005 120/60	3/4", 120/60
SC8221G007 24/60	1", 24/60
SC8221G007 120/60	1", 120/60

BURKERT, 1/2"
Burkert Solenoid with DIN Connection



Part No.	Description
322027	1/2", 24/60
273571	1/2", 120/60

RAINBIRD SOLENOID



Part No.	Description
100PGA-B	1", 24/60
150PGA-B	1-1/2", 24/60
200PGA-B	2", 24/60

DIN CONNECTOR



Part No.	Description
236034.	DIN Connector without Cord
OM550ZRB29NEMA	DIN Connector and Cord with 120V Grounded Plug

WEATHERMATIC SOLENOID



Part No.	Description
11024FCR-10D	1", 24/60
11024FCR-15D	1-1/2", 24/60
11024FCR-20D	2", 24/60

FLOW METERS

3-9900-1 LCD TRANSMITTER



Signet Field Mount LCD Transmitter

Flow Range:
0 to 99999 GPM

Power Requirement:
12-32VDC

3-8050 MOUNTING KIT



Signet Field Mount LCD Transmitter

Signet 8050 Universal Mounting Kit for use with LCD Transmitter

WSU240-0500-R POWER SUPPLY



Signet Field Mount LCD Transmitter

Triad Power Supply :
120VAC

Two Prong to 24VDC
Two Wire

IMPACT FLOW METER

Blue-White Horizontal Flow Meter

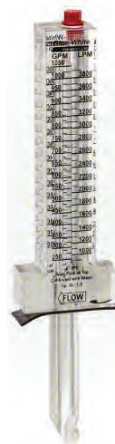

Part No.	Size	SCH 40 GPM	SCH 80 GPM
F-30100P	1"	5-35	4-26
F-30150P	1.5"	10-70	10-60
F-30200P	2"	20-120	18-100
F-30250P	2.5"	29-150	25-130
F-30300P	3"	45-240	40-215
F-30400P	4"	75-420	70-375
F-30600P	6"	170-1100	160-1000
F-30800P	8"	300-2200	275-1950

MAGNETIC FLOW SENSOR FREQUENCY OUTPUT



3-2551-P0-11	1/2" to 4" pipe size
3-2551-P1-11	5" to 8" pipe size
3-2551-P2-11	10" to 36" pipe size

4 to 20 mA Output

3-2551-P0-12	1/2" to 4" pipe size
3-2551-P1-12	5" to 8" pipe size
3-2551-P2-12	10" to 36" pipe size

Signet 2551 Magmeter insertion type magnetic flow sensor with no moving parts, frequency output, 24VDC power requirement, use with 9900 display transmitter - not included

515 ROTOR-X



Signet 515 Roto-X paddlewheel flow sensor - use with 9900 display transmitter - not included

P51530-P0	1/2" to 4" pipe size
P51530-P1	5" to 8" pipe size
P51530-P2	10" to 36" pipe size

CLAMP-ON SENSOR SADDLE SCH 80



PV8S020	2"
PV8S025	2-1/2"
PV8S030	3"
PVUS040	4"
PVUS060	6"
PV8S080	8"

GLUE-ON SENSOR SADDLE SCH 80



PV8S100	10"
PV8S120	12"

FLOWVIS



Ingenious in concept and flawless in operation.

FV-15-U	1.5" Pipe Size
FV-2-U	2" Pipe Size
FV-3	3" Pipe Size



1000-6376 GAUGE
N-B 4.5 Panel Mount
0 to 60PSI



190059 GAUGE
Triton 2-1/2", 0 to 60 PSI, 1/4" MIPT Back Connection



ILCG36025-4LNL. GAUGE
2-1/2" Liquid Filled,
30-0-60, 1/4" MIPT
Lower Connection



ILPG6025-4LNL. GAUGE
2-1/2" Liquid Filled,
0-60, 1/4" MIPT
Lower Connection



ILPG30025-4LNL. GAUGE
2-1/2" Liquid Filled,
0-300, 1/4" MIPT
Lower Connection



ILVG3025-4LNL GAUGE
2-1/2" Liquid Filled,
30-0, 1/4" MIPT
Lower Connection



PGBS1/4 SNUBBER
1/4" MIPT x 1/4"
FIPT (for gauges),
Brass Snubber



T38 301331TC STOPCOCK
1/4" FIPT x 1/4" FIPT,
Brass Stopcock

GAUGES / THERMOMETERS



310DVU35 THERMOMETER

Vari-Angle Digital
Solar Thermometer

E35-75BS BRASS WELL



Brass Well
3-1/2" Stem 3/4"



R141200 THERMOMETER

Pentair E-Z Read
Thermometer
Model 136

SL1DW THERMOMETER



Inline Thermometer
with Nylon Well

DEFENDER - REGENERATIVE



**1000-5531
WATER SEPARATOR**
1/2" FNPT x 3/8"
Auto-Drain



**1000-4204
VIEWING WINDOW
GASKET**
5-1/6" OD x 3-7/8" ID x
1/8" Thick



**1000-5527
FILTER REGULATOR**
1/2" FNPT x 3/8"
Auto-Drain



**1000-4243
VIEWING WINDOW
GASKET**
7-3/4" OD x 6" ID x
1/8" Thick



**11499
FILTER ELEMENT**
Vacuum Transfer
Filter



**FG-1032000+01
MEDIA VAC LID**
7-3/8" OD x 7-1/4" ID
x 5/8" Height



**DMVFE95
FILTER ELEMENT**
Vacuum Transfer
Filter



**RTE-P1AF20
ELECTRONIC TIMER**
100-240 VAC, Pin
Type Connection



**AS2301F-N02-07SA
FLOW CONTROL**
Elbow Type / Universal
.250 MIPT x .250
Tubing Connection

**AS2301F-N01-07SA
FLOW CONTROL**
Elbow Type / Universal
.125 MIPT x .250
Tubing Connection



**AN40-N04
EXHAUST MUFFLER**
1/2" MIPT

**6F600
EXHAUST MUFFLER**
3/4" MIPT



**KQ2H07-35AS
QUICK CONNECT
FITTING**
Straight .250" MIPT x
.250" Tubing Connection

**KQ2H11-36S
QUICK CONNECT
FITTING**
Straight .375" MIPT x
.375" Tubing Connection



**SY7140-3DZ
SOLENOID VALVE**
120VAC Coil

**SY7140-5DZ
SOLENOID VALVE**
24VDC Coil

MULTIPOINT VALVES / PENTAIR EQ STRAINER PARTS



**AQ5000-N04
EXHAUST VALVE**
1/2" FNPT



**11272
INDICATOR BULB**
60V, 20mA



**1000-5528
MANWAY GASKET**
14" x 18" x .250" for
Fiberglass Tanks



**1000-7179
MANWAY GASKET**
14" x 18" x .250"



**1000-6657
SPIDER YOKE**
Two-Hole Type for
Fiberglass Filters

**261050
HI-FLOW MULTIPOINT VALVE**



Hi-Flow Multipoint Valve
7-1/2" Centerline with 2" slip
connections.

**261055
MULTIPOINT VALVE**



Multipoint Valve for Triton
(SM20-3), 7-1/2" Centerline
with 2" threaded female
connections.



**350171
CLAMP CAM**
Clamp Cam and
Ramp (No Lid)



**350166
LID GASKET**



**357161Z
DRAIN PLUG**



**356750
CLEAR LID**



**357184
STRAINER BASKET**



**192115Z
DRAIN PLUG
O-RING**

NEPTUNE BENSON STRAINER PARTS

FILTER / STRAINER PARTS



**1000-6432
GASKET**

12.25" OD
10.875" ID x
.250" Thick

For Guardian 5" and 8" H
and L Strainers



**1000-6429
GASKET**

18.00" OD
16.375" ID
.250" Thick

For Guardian 10" and 12"
H and L Strainers



**1000-6427
GASKETS**

10.125" OD
8.75" ID
.250" Thick

For Guardian 3" and 4" H
& L Strainers



**3.8PLAWASH
NYLON WASHER**



**1509489T73
EYEBOLT**
16 x 3.75"



**1000-5457
SECURING KNOB**
3/8-16



STRAINER LID



STRAINER BASKET

*CONTACT US FOR PART NUMBER



Water Chemistry and Equipment Room Controls



BECSys Live! provides simple and secure 24/7 real-time access to BECSys controllers.

- ✓ It's really easy
- ✓ Highly secure
- ✓ Real-time dashboards
- ✓ Change settings
- ✓ Review graphs
- ✓ Run reports

And best of all, it's free!

Visit becsys.live to learn more and get started.

Run Reports



Real-time Dashboards



Review Graphs

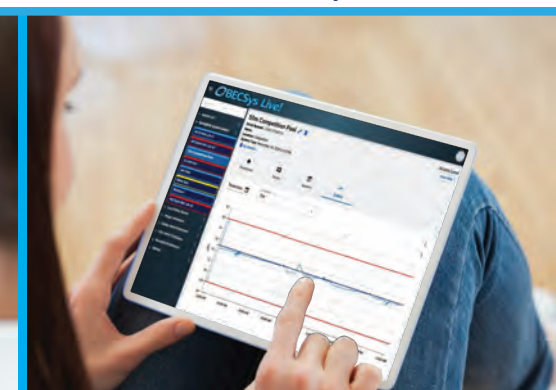

Providing the world's most advanced water chemistry solutions





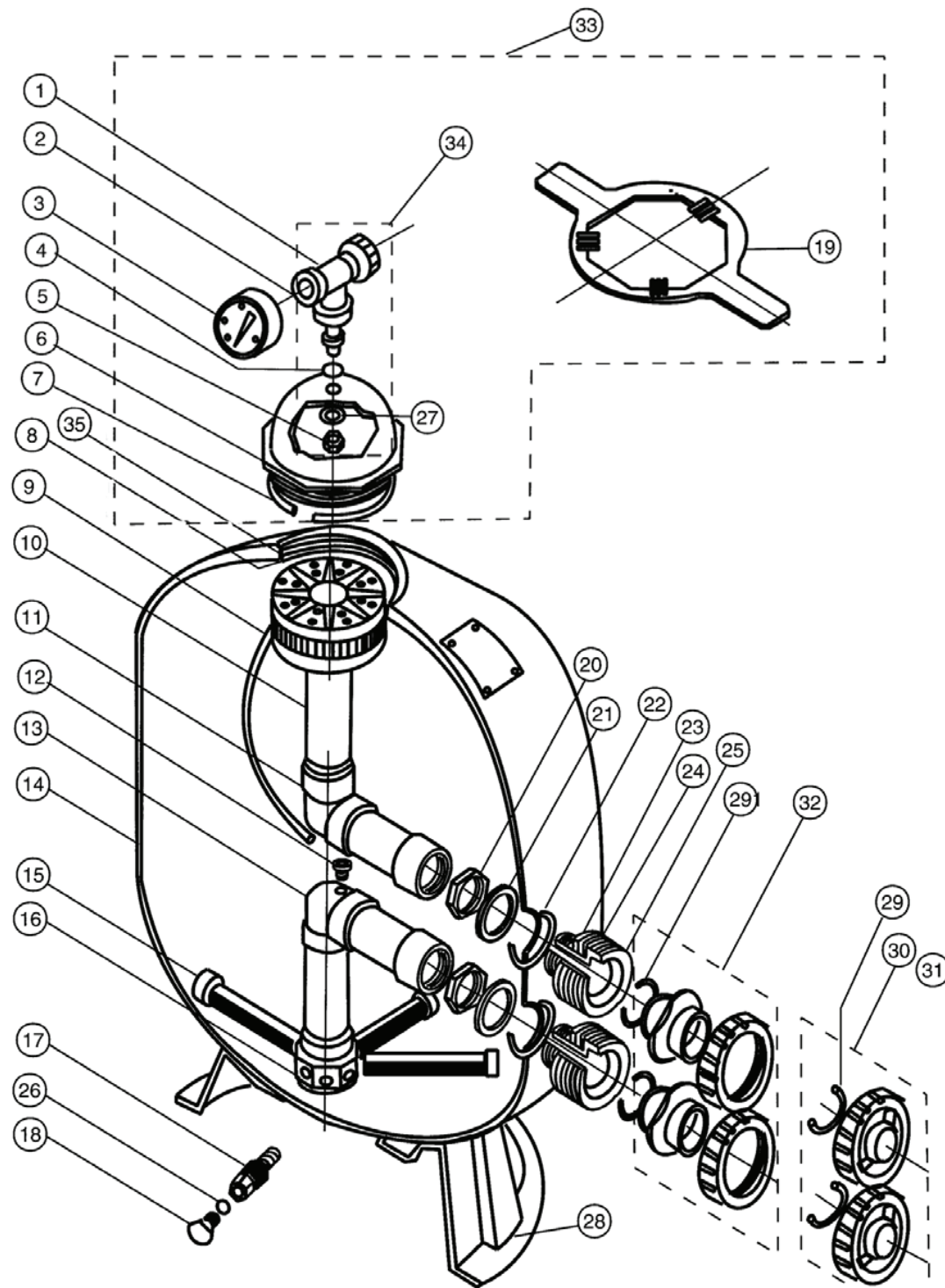

Detail A after 12/1/91
6 in. btr. Thread.



Detail B before 12/1/91
6 in. "V" Thread.

Filters manufactured after Dec 1, 1991 utilize a 6 in. btr. thread in the filter tank top opening and on the closure, see Detail A. Filters manufactured before Dec 1, 1991 utilize a 6 in. "V" type thread, see Detail B. 6 in. closures in Detail A and B are NOT interchangeable.

- | | |
|---|--|
| 1 Used on filters manufactured before 2-89. | 9 For installations w/out valve, pair. |
| 2 Used on filters manufactured after 2-89. | 10 Used on all TR100 & 140 filters manufactured after 10-1-01. |
| 3 All filters manufactured before 11-1-99. | 11 Replacement of tank foot requires the use of foot mounting tape. |
| 4 Used on filters manufactured after 11-1-99. | See P/N's. |
| 5 Used on filters manufactured before 5-85. | 12 Fitting package includes items 1,2,4,5 and 27. |
| 6 Used on filters manufactured after 5-85. | 13 For individual parts for closure kit for TR100 and TR140 see replacement parts pages. |
| 7 Used on filters manufactured before 3-83. | 14 For TR60's built after 6-07. |
| 8 Used on filters manufactured after 3-83. | |

Item	Description	Part #
1	Air bleeder/tee assembly 13	154689
2	Adapter, brass air bleeder 13	154700
3	Gauge, back mount pressure 13	190059
4	O-ring, air bleeder adapter 13	154661
5	Nut, 3/8 in., 16 SS 13	154664
6	Closure 6 in. "V" thread, black, see Detail B 13	154559
7	O-ring closure, 6 in., white 13	154493
8	Strainer air relief, 1/4 in. 3	154578
8	Strainer air relief, 3/8 in. 4	150035
9	Tube air relief TR40 3	154435
9	Tube air relief TR40 4	150039
9	Tube air relief TR50/60 3	154436
9	Tube air relief TR50/60 4	150040
9	Tube air relief TR100 3	154437
9	Tube air relief TR100 4	150041
9	Tube air relief TR140 3	154438
9	Tube air relief TR140 4	150042
10	Diffuser assembly TR40/50	154598
10	Diffuser assembly TR60	154599
10	Diffuser assembly TR100	154462
10	Diffuser assembly TR140	154906
11	Piping assembly upper TR40	154803
11	Piping assembly upper TR50	156814
11	Piping assembly upper TR60	154533
11	Piping assembly upper TR100	154426
11	Piping assembly upper TR140	154500
12	Connector air relief tube 3	154441
12	Connector air relief tube 4	150036
13	Piping assembly lower TR40	154801
13	Piping assembly lower TR50	156816
13	Piping assembly lower TR60	154805
13	Piping assembly lower TR60 14	155284
13	Piping assembly lower TR/ PF100	154807

Item	Description	Part #
13	Piping assembly lower TR140	154489
14	Tank & ft. assembly TR40, 6 in. btr. thd., Almond, Detail A	154636
14	Tank & ft. assembly TR50, 6 in. btr. thd., Almond, Detail A	154637
14	Tank & ft. assembly TR60, 6 in. btr. thd., Almond, Detail A	154638
14	Tank & ft. assembly TR100, 8-1/2 in. btr. thd., Almond, Detail A	154639
14	Tank & ft. assembly TR100HD btr. thread, black HD	156224
15	Lateral, 6-11/16 in. L TR40/50/60, 8 req.	152290
15	Lateral TR60 Grey. 1/4 turn 14	150085
15	Lateral, 9-1/8 in. L TR100, 8 req.6	152202
15	Lateral, 12 in. L TR140, 8 req	154540
15	Lateral, ClearPro	150088
16	Hub lateral TR40/50/60	154763
16	Hub lateral, ClearPro- 6 req 14	155753
16	Hub lateral TR100/140	154453
17	Spigot, 3/4 in. NPT sand drain 8	154698
18	Plug, 1/4 in. NPT drain 8	357161
18	Drain Plug Assy	U178-920P
19	Wrench, 6 in. closure 13	154512
19	Wrench closure aluminum, 6 in. 13	154510
20	Locknut, 2 in. internal, 2 req.	154412
21	Spacer, 2 in. internal, 2 req.	154416
22	O-ring, 2 in. bulkhead, 2 req	154492
23	Spacer, 2 in. external, 2 req.	154408
24	Gasket, 2 in. bulkhead, 2 req	154538
25	Bulkhead, 2 in., 2 req.	154405
26	O-ring drain plug 8	192115
27	Washer, 3/8 in. SS 13	154418
28	Foot, 16 in. dia., TR40/50 2, 11	154926
28	Foot, 19 in. dia., TR60 2, 11	154520
28	Foot, 24 in. dia., TR100/140 2, 11	154596
29	O-ring valve adptr., 2 req.	274494
30	2 in. Thread adapter. kit 9	271092
31	1-1/2 in. Thread adapter. kit 9	271094
32	2 in. Slip adapter. kit 9	271096
32	Adapter Kit, 1-1/2 in. x 2 in.	274426
33	Kit closure, 8-1/2 in HD	155738
33	Kit closure, 6 in. btr. thread, black, Detail A 13	154641
33	Spacer air vent strainer, 5 in., TR140	154697
33	Kit closure, 8-1/2 in. btr. thread, black 10, 13	154856
34	Fitting package complete 12, 13	154687
35	Spacer air vent strainer, 3-3/4 in., TR40	154611
35	Spacer air vent strainer, 4-1/2 in., TR50/60	154612
35	Spacer air vent strainer, 5 in., TR140	154613
35	Spacer air vent strainer, 5 in., TR140	154614

Description	Part #
Not Shown	
Tape ft. mounting TR40/50/60, 3 req.	154402
Tape ft. mounting TR100/140, 3 req.	154407
Bulkhead wrench, 2 in.	151602
Bulkhead kit include items 20-25	154714
Aluminum wrench, 8-1/2 in.	151092
Sand drain, 2 in. (used on TR100 and TR140) (Left-hand thread)	152220Z
Cap thd., 1-1/2 in.	154871
Sand drain O-ring TA100 (used on TR100 and TR140)	274494

TRI100C™ & TRI140C™ SAND FILTERS

FILTER / STRAINER PARTS

Item	Description	Part #
1	Air bleeder w/ O-ring	273512
2	O-ring air bleeder screw	273513
3	Manual air relief body assembly	273564
4	Pressure gauge	190059
5	O-ring, 3/16 in. x 2-5/8 in. i.d.	274495
6	Valve body machined ARF	273564
7	Closure, 8-1/2 in. btr.	154575
8	Square ring 8-1/2 in.	152509
9	Diffuser Assembly	154599
10	Piping assembly upper TR100C, TR140C 1	156355
11	Piping assembly upper inlet TR100C, TR140C	156344
12	Piping connecting assembly upper TR140C	156354
14	ank & ft. assembly TR100C, 8-1/2 in. btr. thd., black	153430
14	Tank & ft. assembly TR140C, 8-1/2 in. btr. thd., black	153431
15	Hub lateral TR100C/TR140C	154453
16	Foot, 24 in. dia. TR100C/TR140C	154596
17	Lateral, 9-1/8 in. TR100C, 8 req.	152202
17	Lateral, 12 in. TR140C, 8 req.	154540
18	Locknut, 2 in. internal	154412
19	Spacer, 2 in. internal	154416
20	O-ring, 2 in. bulkhead	154492
21	Spacer, 2 in. external	154408
22	Gasket, 2 in. bulkhead	154538
23	Bulkhead, 2 in.	154405
24	O-ring, 3/16 in. x 2-5/8 in. L.H. Thread	274494
25	2 in. sand drain (Left-hand thread)	152220Z
26	Cap thd., 1-1/2 in.	154871
27	Wrench, 8-1/2 in. closure	154527
28	Piping assembly lower TR100C	154807
28	Piping assembly lower TR140C	154489
29	Connector air relief tube 3	150036
30	Screw, No.14 18-8 TR100C 1	273071
31	Tube air relief TR100C 2	154437
31	Tube air relief TR100C 3	150041
31	Tube air relief TR140C 2	154438
31	Tube air relief TR140C 3	150042
32	Spacer air vent strainer TR100C 6-3/4 in.	154507
32	Spacer air vent strainer TR140C 10-5/16 in.	154508
33	Strainer air relief 2	154578
33	Strainer air relief 3	150035
34	O-ring valve adapter	274494
35	2 in. slip adaptor kit for inst. w/o valve (pair)	271096
35	Adapter Kit, 2-1/2 in. x 2 in.	274426
36	2 in. thd. adaptor kit for inst. w/o valve (pair)	271092
37	1-1/2 in. thd. adaptor kit for inst. w/o valve (pair)	271094
38	Kit closure 8-1/2 in. btr. thd. blk.	154856

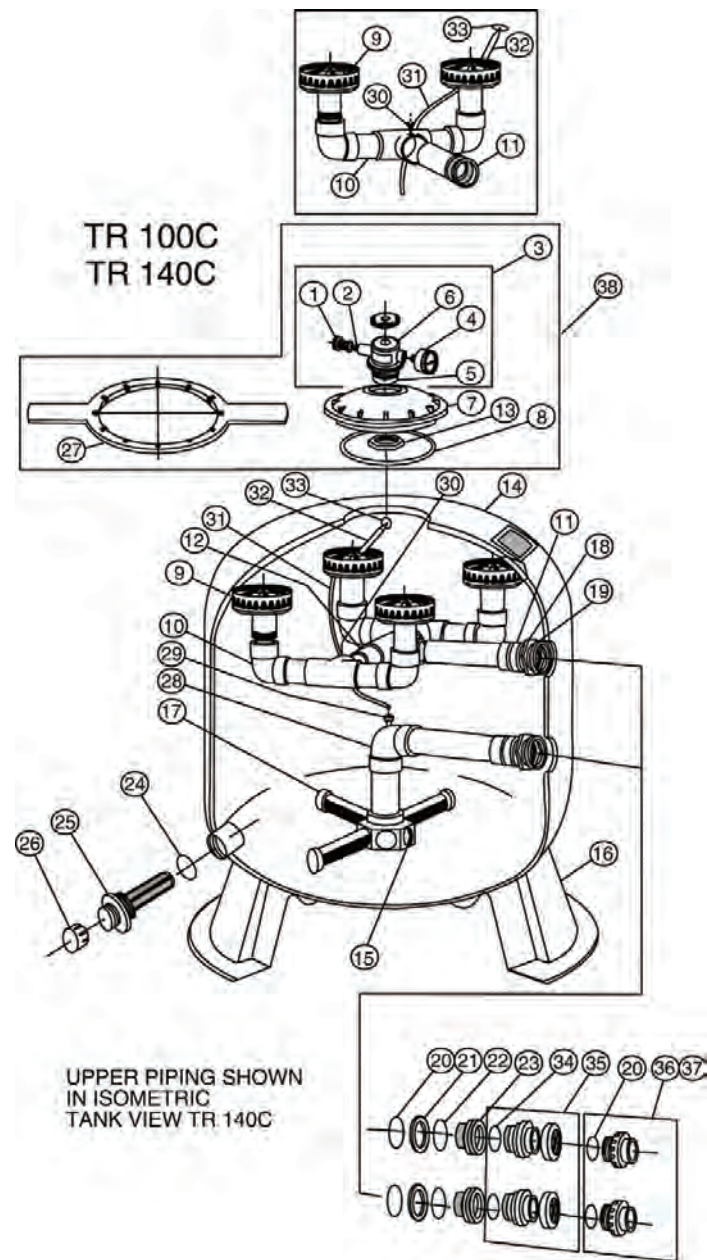

TRITON® C-3 FILTERS

FILTER / STRAINER PARTS

Item	Description	Part #
1	Air bleeder w/ O-ring	273512
2	O-ring air bleeder screw	273513
3	Manual air relief body assembly	273564
4	Pressure gauge	190059
5	O-ring, 3/16 in. x 2-5/8 in. i.d.	274495
6	Valve body machined ARF	273564
7	Closure, 8-1/2 in. btr.	154575
8	Square ring 8-1/2 in.	152509
9	Diffuser Assembly	154599
10	Piping assembly upper TR100C, TR140C 1	156355
11	Piping assembly upper inlet TR100C, TR140C	156344
12	Piping connecting assembly upper TR140C	156354
14	ank & ft. assembly TR100C, 8-1/2 in. btr. thd., black	153430
14	Tank & ft. assembly TR140C, 8-1/2 in. btr. thd., black	153431
15	Hub lateral TR100C/TR140C	154453
16	Foot, 24 in. dia. TR100C/TR140C	154596
17	Lateral, 9-1/8 in. TR100C, 8 req.	152202
17	Lateral, 12 in. TR140C, 8 req.	154540
18	Locknut, 2 in. internal	154412
19	Spacer, 2 in. internal	154416
20	O-ring, 2 in. bulkhead	154492
21	Spacer, 2 in. external	154408
22	Gasket, 2 in. bulkhead	154538
23	Bulkhead, 2 in.	154405
24	O-ring, 3/16 in. x 2-5/8 in. L.H. Thread	274494
25	2 in. sand drain (Left-hand thread)	152220Z
26	Cap thd., 1-1/2 in.	154871
27	Wrench, 8-1/2 in. closure	154527
28	Piping assembly lower TR100C	154807
28	Piping assembly lower TR140C	154489
29	Connector air relief tube 3	150036
30	Screw, No.14 18-8 TR100C 1	273071
31	Tube air relief TR100C 2	154437
31	Tube air relief TR100C 3	150041
31	Tube air relief TR140C 2	154438
31	Tube air relief TR140C 3	150042
32	Spacer air vent strainer TR100C 6-3/4 in.	154507
32	Spacer air vent strainer TR140C 10-5/16 in.	154508
33	Strainer air relief 2	154578
33	Strainer air relief 3	150035
34	O-ring valve adapter	274494
35	2 in. slip adaptor kit for inst. w/o valve (pair)	271096
35	Adapter Kit, 2-1/2 in. x 2 in.	274426
36	2 in. thd. adaptor kit for inst. w/o valve (pair)	271092
37	1-1/2 in. thd. adaptor kit for inst. w/o valve (pair)	271094
38	Kit closure 8-1/2 in. btr. thd. blk.	154856
40	Hub	154016

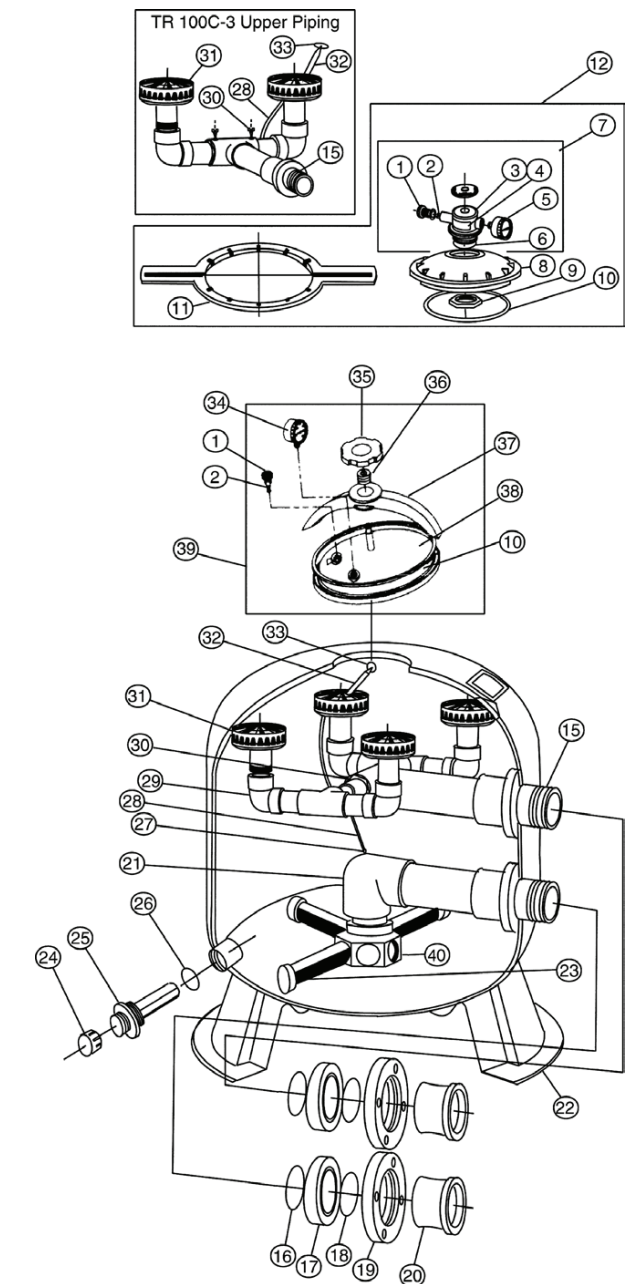

Description	Part #
Not Shown	
Oval Bulkhead Wrench	151600
Oval Bulkhead Wrench	151604
3" Flange Gaskets	150096
Aluminum Wrench	151092

BUOYS / TUBES



RING BUOYS

JBW-20
20", Model #718 White Ring Buoy

JBW-24
24", Model #720 White Ring Buoy

JBW-30
30", Model #723 White Ring Buoy



10-201-RED RESCUE TUBES

50" x 6" x 4" Model #708 Red Guard Water Safety Rescue Tube

UMBRELLAS / WHISTLES



12346.R UMBRELLA
6-1/2' Dia. Red Vinyl Tilting lifeguard Umbrella



12-002-ROY/WHI UMBRELLA
6-1/2' Dia. Specify Color: BW, GW, RW, YW Vinyl Tilting Umbrella



9DLH9 WHISTLE
Classic Safety Black Whistle Only



12356.BK LANYARD
Black Lanyard



BLUE/WHITE ROPE ORDER BY FOOT

Part No.	Description
PR38-6	3/8" Diameter Blue/White Rope
PR50-3	1/2" Diameter Blue/White Rope
PR75-3	3/4" Diameter Blue/White Rope



IFXXXX



R1810XX

ROPE FLOATS

Part No.	Description
IF3538	3" x 5" Handi-Lock, 3/8" Rope Diameter
IF3550	3" x 5" Handi-Lock, 1/2" Rope Diameter
IF5950	5" x 9" Handi-Lock, 1/2" Rope Diameter
IF5975	5" x 9" Handi-Lock, 3/4" Rope Diameter
R181016	3" x 5" Polyethylene, 1/2" Rope Diameter
R181086	5" x 9" Polyethylene, 3/4" Rope Diameter

SAFETY ACCESSORIES



R221026 LIFE HOOK
Life Hook Model 153



R221030 LIFE HOOK HARDWARE
Hardware Mounting Set



10-222-60 60" THROW LINE



R191104 POLE
16' Fiberglass Straight Safety Pole Model 818-16



ROPE HOOKS

Part No.	Description
14452	3/8" Diam. A
14462	1/2" Diam. B
AGHP53	3/4" Diam. C



12449 MYLAR RESCUE BLANKET
52" x 84"



3ARD8 HONEYWELL EYEWASH STATION 32 OUNCE



12448 WOOL RESCUE BLANKET
66" x 84"

FIRST AID / PPE

RESUSCITATION MASKS



540212000
SINGLE USE INFANT RESUSCITATOR

Ambu SPUR II is the only single use resuscitator that is made from a SEBS polymer instead of PVC. This classifies Ambu SPUR II as environmentally safe and fully disposable, thus eliminating all risk of cross contamination. It is part of a complete family of resuscitators, including infant, pediatric, and adult sizes.

520211000
SINGLE USE ADULT RESUSCITATOR

SPINE BOARDS

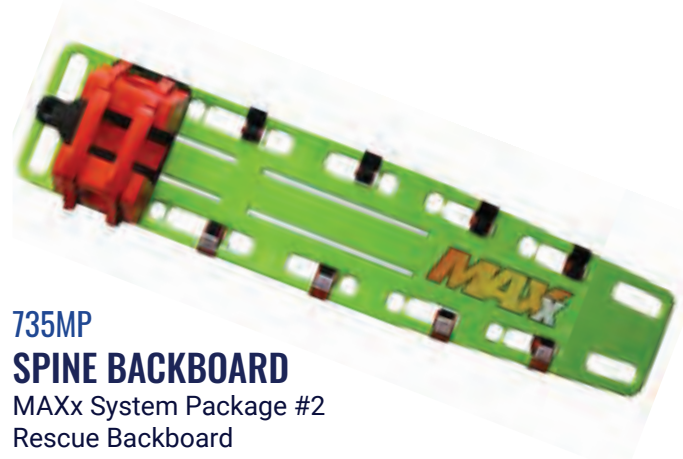

735MP
SPINE BACKBOARD
MAXx System Package #2
Rescue Backboard

735M
SPINE BACKBOARD
MAXx Backboard Only

737V
STRAPS
Velcro Backboard Straps

The MAXx Rescue Backboard is one of the most X-ray translucent backboards available. The 15 pound lightweight, ergonomic design features large non-slip handholds, integrally molded pins, and bottom runners for stability and handhold clearance.



34WK74
FIRST AID KIT
25 Person First Aid Kit



10-001-RED
HEAD IMMOBILIZER



6AD97
RESPIRATOR
Medium Half Mask Respirator Only
(use with 4AD98 Chemical Cartridges)



6003/07047
RESPIRATOR CARTRIDGE
Yellow / 2 Pack Chemical Cartridge
(use with 6AD97 & 6AP71 Mask)



1VT70
SAFETY GOGGLES
Chemical Splash/Impact Resistant Goggles



5T476
SLEEVE PROTECTORS
20" Long Silver Sleeves (Pair)



6784
NEOPRENE GLOVES
14" Long Size 10 Chemical Resistant Gloves (Pair)



93210
ACID APRON
50" Long Green PVC Bib Apron



200-1090A
SECURE KIT
Secure Kit For Pal Lift



400-7000
4-BUTTON LIFT OPERATOR
4-Button LiftOperator Control (Not Keyed)



1001495
BATTERY LIFT OPERATOR



900-1000
SPLASH LIFT SEAT BELT
Splash Lift Seat Belt Assembly



1001600
4-BUTTON HAND CONTROLLER
4-Button Hand Controller 100-4000A



1001550
LIFT OPERATOR UPGRADE KIT

SAFETY SIGNS

FIRE DIAMOND SIGNS



OXIDIZER-CHLORINE / SODIUM HYPOCHLORITE SIGN

5201WS1212E

White Styrene
12" x 12" / 4 - Grommet Mount

3B0R1Y0XW

12" x 12" / Peel and Stick Mount



CORROSIVE-HYDROCHLORIC ACID SIGN

5203WS1212E

White Styrene
12" x 12" / 4 - Grommet Mount

3BOROYCORW

12" x 12" / Peel and Stick Mount



CORROSIVE-SODIUM BISULFATE SIGN

5204WS1212E

White Styrene
12" x 12" / 4 - Grommet Mount

1BOROYW

12" x 12" / Peel and Stick Mount



CORROSIVE-BLEACH SIGN

5205WS1212E

White Styrene
12" x 12" / 4 - Grommet Mount

2BOR1YW

12" x 12" / Peel and Stick Mount



DANGER HAZARDOUS POOL CHEMICALS SIGN

DHC1824

18" x 24" / 4 - Peel and Stick Mount

5001WS1824E

18" x 24" / 4 - Grommet Mount



White Styrene
12" x 18"
4 - Grommet Mount

7067WS1218E

POOL CLOSED SIGN



White Styrene
24" x 30"
4 - Grommet Mount

1802WS2430E

WARNING NO LIFEGUARD ON DUTY SIGN



White Styrene
12" x 10"
4 - Grommet Mount

8310WS1210E-I

MAXIMUM BATHER LOAD SIGN

(Advise capacity to print at no extra charge)



White Styrene
18" x 24"
4 - Grommet Mount

6604WS1824E-I

WARNING NO DIVING ALLOWED SIGN



POOL LIGHTS Intellibrite 5G White LED

Part	Volts/Watts	Incandescent Equivalency	Cord Length
601100	120V, 40W	300W	30'
601101	120V, 40W	300W	50'
601102	120V, 40W	300W	100'
601103	120V, 40W	300W	150'
601104	120V, 40W	300W	250'
601105	12V, 40W	300W	30'
601106	12V, 40W	300W	50'
601107	12V, 40W	300W	100'
601108	12V, 40W	300W	150'
601200	120V, 48W	400W	30'
601201	120V, 48W	400W	50'
601202	120V, 48W	400W	100'
601203	120V, 48W	400W	150'
601204	120V, 48W	400W	250'
601205	12V, 48W	400W	30'
601206	12V, 48W	400W	50'
601207	12V, 48W	400W	100'
601208	12V, 48W	400W	150'
601300	120V, 55W	500W	30'
601301	120V, 55W	500W	50'
601302	120V, 55W	500W	100'
601303	120V, 55W	500W	150'
601304	120V, 55W	500W	250'
601305	12V, 55W	500W	30'
601306	12V, 55W	500W	50'
601307	12V, 55W	500W	100'
601308	12V, 55W	500W	150'



SPA LIGHTS

Intellibrite 5G White LED

Part	Volts/Watts	Incandescent Equivalency	Cord Length
640140	120V, 18W	100W	30'
640141	120V, 18W	100W	50'
640142	120V, 18W	100W	100'
640143	120V, 18W	100W	150'
640144	120V, 18W	100W	250'
640150	12V, 18W	100W	30'
64151	12V, 18W	100W	50'
61153	12V, 18W	100W	100'
640152	12V, 18W	100W	150'

Additional lights and parts available. Please contact parts department for assistance.

POOL CLEANING / MAINTENANCE

R121230
LEAF RAKE



Pro leaf rake with 3/8 Inch aluminum anodized frame and rubber squeegee strip easily removes leaves and debris from bottom of pool.

R121196
HAND SKIMMER NET



Pentair professional grade heavy-duty hand skimmer with 3/8 Inch aluminum anodized support and ABS frame stands up to tough wear.

PB-12
POOL BLOK



5-34" x 2-3/4" x 2-3/4" Pool Blok Tile & Concrete Cleaner

SP1056
HYDROSTATIC RELIEF VALVE



1-1/2" / 2" Spring Loaded with O-Ring Included

R22001Z
POLE SPRING CLIP



Spring Clip For Cleaning Poles

R221036
POLE HANGER



Model 145 / Pair

R19109Z
FIBERGLASS POLES

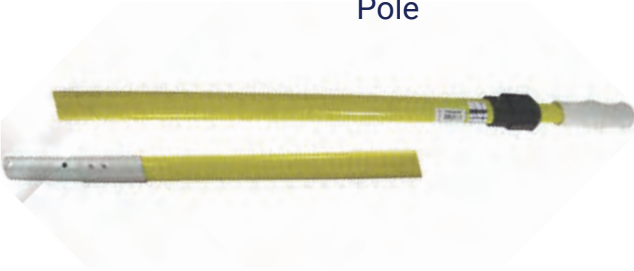

8' to 16' Commercial Telescopic Cleaning Pole

ALUMINUM POLES



R191088
12' to 23-1/2' Commercial Telescopic Pole

R191046
8' to 15-1/2' Two Piece Telescopic Cleaning Pole

R111316
18" CURVED NYLON POOL CLEANING BRUSH



R111342
24" CURVED NYLON POOL CLEANING BRUSH



R111584
10" ACID WASH BRUSH



BRUSHES / VACUUMS / HOSES

VACUUM HEAD



R201126
19" ProVac Flexible Commercial Vacuum Head

R201286
22" ProVac Flexible Commercial Vacuum Head

VACUUM HOSE



10404
1-1/2" x 50' Vacuum Hose W/Swivel

10422
2" x 50' Vacuum Hose W/Swivel

DISCHARGE HOSE



10438
1-1/2" x 50'

QT-262-1
2" x 50'

STEPS



44101
LADDER STEP 19" VERTICAL
19" Vertical UV Inhibited ABS, Step



44104
LADDER STEP 19" SLOPING
19" Sloping UV Inhibited ABS, Step

44107
LADDER STEP 26" VERTICAL



26" Vertical UV Inhibited
ABS, Step

44109
LADDER STEP 26" SLOPING



26" Sloping UV Inhibited
ABS, Step

60-701
HARDWARE ONLY



Hardware Only for 2
Treads (For use with SR
Smith LTDF-103 step)

LTDF-103
SR SMITH LADDER STEP



Step Only, SR Smith
Ladder 20" Elite Stainless
Steel Tread (use 60-701
hardware kit if required)



PARTNER OF CHOICE

TRUSTED
SINCE 1956

PROVEN PORTFOLIO OF SOLUTIONS FOR THE GLOBAL AQUATICS MARKET

Our market-leading technologies will help meet your goals for:

- Sustainability
- Operational & cost efficiency
- Water and air quality
- Enhanced guest experience

evoqua.com/aquatics
+1-401-821-2200

Neptune Benson
EVOQUA





MALE COUPLER

Tubing Outside Diameter
x Male Pipe Thread

Part	Tubing	MNPT
P4MC4	1/4	1/4
P6MC4	3/8	1/4
P6MC6	3/8	3/8
P6MC8	3/8	1/2
P6MC12	3/8	3/4
P8MC4	1/2	1/4
P8MC6	1/2	3/8
P8MC8	1/2	1/2
P8MC12	1/2	3/4
P10MC8	5/8	1/2
P10MC12	5/8	3/4



MALE ELBOW

Tubing Outside Diameter
x Male Pipe Thread

Part	Tubing	MNPT
P4ME4	1/4	1/4
P6ME4	3/8	1/4
P6ME6	3/8	3/8
P6ME8	3/8	1/2
P8ME6	1/2	3/8
P8ME8	1/2	1/2
P10ME8	5/8	1/2



UNION COUPLER

Tubing Outside Diameter
x Tubing Outside Diameter

Part	Tubing	Tubing
P4UC4	1/4	1/4
P6UC4	3/8	1/4
P6UC6	3/8	3/8
P8UC6	1/2	3/8
P8UC8	1/2	1/2
P10UC8	5/8	1/2
P10UC10	5/8	5/8



FEMALE COUPLER

Tubing Outside Diameter
x Female Pipe Thread

Part	Tubing	FNPT
P4FC4	1/4	1/4
P6FC4	3/8	1/4
P6FC6	3/8	3/8
P6FC8	3/8	1/2
P8FC6	1/2	3/8
P8FC8	1/2	1/2
P10FC8	5/8	1/2



FEMALE ELBOW

Tubing Outside Diameter
x Female Pipe Thread

Part	Tubing	FNPT
P6FE4	3/8	1/4
P6FE6	3/8	3/8
P8FE6	1/2	3/8
P8FE8	1/2	1/2
P10FE8	5/8	1/2



MALE TEE

Tubing Outside Diameter
x Male Pipe Thread

Part	Tubing	MNPT
P4MT4	1/4	1/4
P6MT4	3/8	1/4
P8MT8	1/2	1/2



REPLACEMENT PARTS

Tubing	Grip-Ring	O-Ring	Nut	Spacer
1/4	4GR	4OR	P4N	P4S
3/8	6GR	6OR	P6N	P6S
1/2	8GR	8OR	P8N	P8S
5/8	10GR	10OR	P10N	P10S



UNION TEE

Tubing Outside Diameter

Part	Tubing
P4TU4	1/4
P6TU6	3/8
P8TU8	1/2
P10TU10	5/8

BALL CHECK VALVES / BALL VALVES

TRUE UNION BALL CHECK VALVE PVC



Hayward True Union Ball Check Valve S/T, PVC, EPDM

Part No.	Size
TC10050STE	1/2"
TC10075STE	3/4"
TC10100STE	1"
TC10150STE	1-1/2"
TC10200STE	2"
TC1250SE	2-1/2"

TRUE UNION BALL VALVE PVC



Hayward True Union Ball Valve S/T, PVC, EPDM

Part No.	Size
TBH1050ASTE0000	1/2"
TBH1075ASTE0000	3/4"
TBH1100ASTE0000	1"
TBH1150ASTE0000	1-1/2"
TBH1200ASTE0000	2"
TBH2100ASTE0000	1"
TBH2150ASTE0000	1-1/2"
TBH2200ASTE0000	2"
TBH2250ASTE0000	2-1/2"

ASAHI PVC OMNI TYPE 27 COMPACT BALL VALVE SOCKET



Part No.	Size
161070005	1/2"
161070007	3/4"
161070010	1"

ASAHI PVC OMNI TYPE 27 COMPACT BALL VALVE THREADED



Part No.	Size
161071005	1/2"
161071007	3/4"
161071010	1"

DOMINION BUTTERFLY VALVE



Dominion butterfly valve, Rilsan (nylon) coated cast aluminum housing, Rilsan (nylon) ductile iron disc, lever, gear, electric or pneumatic operators available.

Part No.	Size
1000-7325	2"
1000-7326	2.5"
1000-7327	3"
1000-7328	4"
1000-7330	5"
1000-7351	4"
1000-2016	6"
1000-7332	8"
1000-7333	10"
1000-7335	12"

ASAHI POOL-PRO PVC BUTTERFLY VALVE



Butterfly valve with plasgear and hand wheel.

Part No.	Size
3793015	1-1/2"
3793020	2"
3793025	2-1/2"
3793030	3"
3793040	4"
3793060	6"
3793080	8"
3793100	10"
3793120	12"

ASAHI POOL-PRO LEVER HANDLE



Replacement lever handle. (Only for Asahi)

Part No.	Size
1764021	1.5" to 2.5"
1764041	3" to 4"
1764061	6"
1764081	8"

BUTTERFLY VALVES

ASAHI BUTTERFLY VALVE



Asahi Pool-Pro PVC butterfly valve with lever.

Part No.	Size
1728015	1.5"
1728020	2"
1728025	2.5"
1728030	3"
1728040	4"
1728060	6"
1728085	8"

DOMINION LEVER HANDLE



Lever Handle Only for Dominion Butterfly Valve

Part No.	Size
1000-7355	2" to 3"
1000-7357	6" to 8"
1000-2017	4"

ASAHI POOL-PRO PVC BUTTERFLY VALVE BARE STEM



Asahi Pool-Pro PVC butterfly valve bare stem

Part No.	Size
3793101	10"
3793121	12"

BUTTERFLY VALVE ACCESSORIES

DOMINION GEAR OPERATOR



Part No.	Size
1000-6095	2" to 3"
1001-7875	4"
1000-7675	6" to 8"
1001-6095	10" to 12"

Gear Operator Only for Dominion Valves Hardware

HAND WHEEL FOR DOMINION BUTTERFLY VALVES



Part No.	Size	Fits
1001-3561	6"	2" to 5" BFV
1000-5416	10.5"	6" to 12" BFV

MARSH BELLOFRAM PRESSURE TRANSDUCER



Part No.
961-111-000

Marsh Bellofram current to pressure transducer for modulating, 4~20MA, 1/4"NPT, 3 to 120PSI

ASAHI BFV RETAINER RING



Part No.	Size
3701100	10" BFV
3701140	12" BFV

BUTTERFLY VALVE ACCESSORIES

ASAHI SSG STEM EXTENSION ADAPTER



Part No.	Fits
123766040	3" to 4" BFV
123766060	6" BFV
123766080	8" BFV
123766100	10" BFV
123766120	12" BFV

Asahi SSG Stem Adapters 316SS for Asahi BFV. Also consider purchasing P/N 3701100 Retainer Ring for 10" BFV and P/N 3701140 for 12" BFV.

KAMMAC SPRING RETURN ACTUATOR



Part No.	Fits
A PA-SR75-S12-3-4	3" to 4" BFV
A PA-SR83-S12-6	6" BFV
A PA-SR105-S12-8	8" BFV
A PA-SR140-S12-10	10" BFV
A PA-SR140-S12-12	12" BFV

Kammac Spring Return Actuator and adapter kit for Asah BFV.

PNEUMATIC ACTUATOR DOUBLE ACTING



Part No.	Size
PN-75-DA	3" to 4"
PN-100-DA	6" to 8"
PN-125-DA	10" to 12"

Pneumatic Actuator Double Acting for Dominion Valves

SQUARE TUBE STOCK STAINLESS



Part No.	Size
14604550	Square Tube Stock for Extension Handle, Stainless Steel - sold per foot

STAINLESS STEEL TEE HANDLE



Part No.	Size
1000-7298	Tee Handle, Stainless Steel for Extension Handle 18" x 24"

FOOT VALVES / WAFER CHECK VALVES

PRATT FLEXIBLE CHECK VALVE



Pratt Series 851A Flexible Check Valve with Epoxy Coated Ductile Iron Body, 3/4" Drain and Stainless Steel Hardware, 250 PSI

Part No.	Size
0300-851A-1	3"
0400-851A-1	4"
0600-851A-1	6"
0800-851A-1	8"
1000-851A-1	10"
1200-851A-1	12"

CHECK VALVE



Swing Type HDPE Compact Poly Foot Valve, Flanged, ANSI 125

Part No.	Size
0200-851A-1	6"
0300-851A-1	8"
0600-851A-1	10"
0800-851A-1	12"

CENTERLINE WAFER CHECK VALVE



Centerline 800 Series Wafer Check Valve, Cast Iron Body, Stainless Steel Discs

Part No.	Size
800SCV2.5	2-1/2"
800SCV3	3"
800SCV4	4"
800SCV6	6"
800SCV8	8"
800SCV10	10"
800SCV12	12"

METRAFLEX WAFER CHECK VALVE



Metraflex Series CVXXK Wafer Check Valve, Epoxy Coated Cast Iron Body, Stainless Steel Discs

Part No.	Size
CVXXK0300	3"
CVXXK0400	4"
CVXXK0600	6"
CVXXK0800	8"
CVXXK1000	10"
CVXXK1200	12"

PVC CEMENT



717QG
1 Quart



717GG
1 Gallon

Heavy bodied, medium setting, low VOC PVC cement for all classes and schedules with interference fit through 12-inch diameter pipe and fittings.



727QC
PVC CEMENT
1 Quart

Medium bodied, very fast setting, low VOC PVC cement for all classes and schedules with interference fit through 6-inch diameter pipe and fittings in temperatures between -15 and 110 degrees F.



724QG
CPVC CEMENT
1 Quart

Heavy bodied, medium setting, low VOC CPVC cement for all classes and schedules with interference fit through 12-inch diameter pipe and fittings.

CEMENT & PRIMER

PVC/CPVC PRIMER



P70QC
1 Quart



P70GC
1 Gallon

Industrial grade, low VOC, non-bodied, fast acting primer. Suitable for use with with all types, classes, and schedules of PVC and CPVC pipe and fittings.



MT-648
EMPTY CAN
1 Gallon

Empty Can With
2-7/8" Neck



4020
SWAB 4"

Swab for pipe sizes 6" and larger, use with MT-648 one gallon can

SCH 80 PVC / TEES / NINETYS



SCH 80 NINETY SOCKET

Part	Size "
806-005	1/2
806-007	3/4
806-010	1
806-015	1-1/2
806-020	2
806-025	2-1/2
806-030	3
806-040	4
806-060	6
806-080	8



SCH 80 NINETY FEMALE THREAD

Part	Size "
808-002	1/4
808-003	3/8
808-005	1/2
808-007	3/4
808-010	1
808-012	1-1/4
808-015	1-1/2
808-025	2-1/2
808-020	2
808-030	3
808-040	4

PVC SCHEDULE 80 PIPE

Part	Size (Inches)
800-005	1/2
800-007	3/4
800-010	1
800-015	1-1/2
800-020	2
800-025	2-1/2
800-030	3
800-040	4
800-060	6
800-080	8
800-100	10
800-120	12

SCH 80 TEE SOCKET

Part	Size (Inches)
801-002	1/4
801-003	3/8
801-005	1/2
801-007	3/4
801-010	1
801-015	1-1/2
801-020	2
801-025	2-1/2
801-030	3
801-040	4
801-060	6
801-080	8

SCH 80 TEE FEMALE PIPE THREAD

Part	Size (Inches)
805-002	1/4
805-005	1/2
805-007	3/4
805-010	1



SCH 80 FORTY-FIVES / COUPLINGS

SCH 80 45 DEGREE SOCKET

Part	Size "
817-005	1/2
817-007	3/4
817-010	1
817-012	1-1/4
817-015	1-1/2
817-020	2
817-030	3
817-040	4
817-060	6
817-080	8
817-100	10
817-120	12



SCH 80 45 DEGREE SOCKET



SCH 80 45 DEGREE FEMALE THREAD

SCH 80 45 DEGREE FEMALE THREAD

Part	Size "
819-002	1/4
819-005	1/2
819-007	3/4
819-010	1
819-015	1-1/2
819-020	2
819-003	3/8
819-012	1-1/4
819-025	2-1/2
819-030	3
819-040	4



SCH 80 COUPLING SOCKET



SCH 80 COUPLING FEMALE THREAD

SCH 80 COUPLING SOCKET

Part	Size "
829-002	1/4
829-003	3/8
829-005	1/2
829-007	3/4
829-010	1
829-012	1-1/4
829-015	1-1/2
829-020	2
829-025	2-1/2
829-030	3
829-040	4
829-060	6
829-080	8
3929-100-D-S	10 FAB.
3929-120-D-S	12 FAB.

SCH 80 COUPLING FEMALE THREAD

Part	Size "
830-002	1/4
830-003	3/8
830-005	1/2
830-007	3/4
830-010	1
830-012	1-1/4
830-015	1-1/2
830-020	2
830-025	2-1/2
830-030	3
830-040	4

SCH 80 ADAPTERS / COUPLINGS / PLUGS

SCH 80 ADAPTER SOCKET X FEMALE THREAD (SxFPT)

Part	Size "
835-002	1/4
835-003	3/8
835-005	1/2
835-007	3/4
835-010	1
835-012	1-1/4
835-015	1-1/2
835-020	2
835-025	2-1/2
835-030	3
835-040	4

SCH 80 ADAPTER SOCKET X MALE THREAD (SxMPT)

Part	Size "
836-005	1/2
836-007	3/4
836-010	1
836-012	1-1/4
836-015	1-1/2
836-020	2
836-025	2-1/2
836-030	3
836-040	4



**SCH 80
ADAPTER
SOCKET X
FEMALE
THREAD
(SxFPT)**



**SCH 80
REDUCER
COUPLING
SOCKET**



**SCH 80
ADAPTER
SOCKET X
MALE PIPE
THREAD
(SxMPT)**



**SCH 80
PLUG
MALE PIPE
THREAD**

SCH 80 REDUCER COUPLING SOCKET

Part	Size "
829-249	2 x 1
829-338	3 x 2
829-420	4 x 2
829-422	4 x 3
829-532	6 x 4
829-585	8 x 6
829-626	10 x 6
829-628	10 x 8
829-101	3/4 x
829-668	12 x 8

SCH 80 PLUG MALE THREAD (MPT)

Part	Size "
850-002	1/4
850-003	3/8
850-005	1/2
850-007	3/4
850-010	1
850-012	1-1/4
850-015	1-1/2
850-020	2
850-025	2-1/2
850-030	3
850-040	4

SCH 80 CAPS / UNIONS / FLANGES



**FLANGE SPIG
VAN STONE GLASS
FILLED PVC RING
(FLANGE-SLIP)**

854-030HD	3"
854-040HD	4"
854-050	5"
854-060HD	6"
854-080HD	8"
854-100HD	10"
854-120HD	12"
854-140HD	14"
854-160	16"



**FLANGE S
VAN STONE GLASS
FILLED PVC RING
(FLANGE-SLIP)**

856-030	3"
856-040	4"
856-060	6"
856-080	8"
856-100	10"
856-120	12"



**FLANGE
GASKET
NEOPRENE**

154700030	3"
154700040	4"
154700060	6"
154700080	8"
154700100	10"
154700120	12"



**SCH 80 CAP
SOCKET
(CAP-SOCKET)**

847-002	1/4"
847-003	3/8"
847-005	1/2"
847-007	3/4"
847-010	1"
847-012	1-1/4"
847-015	1-1/2"
847-020	2"
847-025	2-1/2"
847-030	3"
847-040	4"
847-060	6"
847-080	8"
847-100	10"
847-120	12"



**SCH 80 CAP
FEMALE THREAD
(CAP-FEMALE)**

848-002	1/4"
848-003	3/8"
848-005	1/2"
848-007	3/4"
848-010	1"
848-012	1-1/4"
848-015	1-1/2"
848-020	2"
848-025	2-1/2"
848-030	3"
848-040	4"



**SCH 80 UNION
SOCKET
(SOCKET UNION)**

897-002	1/4"
897-005	1/2"
897-007	3/4"
897-010	1"
897-015	1-1/2"
897-020	2"
897-025	2-1/2"
897-030	3"
897-040	4"



**SCH 80 UNION
THREADED**

898-002	1/4"
898-005	1/2"
898-007	3/4"
898-010	1"
898-015	1-1/2"
898-020	2"

SCH 80 REDUCER BUSHINGS / NIPPLES

SCH 80 NIPPLES



REDUCER BUSHING
SPIG X SOCKET (SPIGxS)

REDUCER BUSHING
SPIG X FEMALE PIPE THREAD (SPIGxFPT)

REDUCER BUSHING
MALE PIPE THREAD X FEMALE PIPE
THREAD (MPTxFPT)

Part	Size "
837-101	3/4 x 1/2
837-130	1 x 1/2
837-131	1 x 3/4
837-209	1-1/2 x 1/2
837-210	1-1/2 x 3/4
837-211	1-1/2 x 1
837-247	2 x 1/2
837-248	2 x 3/4
837-249	2 x 1
837-291	2-1/2 x 1-1/2
837-292	2-1/2 x 2
837-335	3 x 1
837-337	3 x 1-1/2
837-338	3 x 2
837-339	3 x 2-1/2
837-420	4 x 2
837-422	4 x 3
837-528	6 x 2
837-530	6 x 3
837-532	6 x 4
837-585	8 x 6
837-626	10 x 6
837-628	10 x 8
837-668	12 x 8
837-670	12 x 10

Part	Size "
838-072	1/2 x 1/4
838-098	3/4 x 1/4
838-101	3/4 x 1/2
838-130	1 x 1/2
838-131	1 x 3/4
838-209	1-1/2 x 1/2
838-210	1-1/2 x 3/4
838-211	1-1/2 x 1
838-247	2 x 1/2
838-248	2 x 3/4
838-249	2 x 1
838-251	2 x 1-1/2
838-334	3 x 3/4
838-335	3 x 1
838-337	3 x 1-1/2
838-338	3 x 2

Part	Size "
839-072	1/2 x 1/4
839-098	3/4 x 1/4
839-101	3/4 x 1/2
839-128	1 x 1/4
839-130	1 x 1/2
839-131	1 x 3/4



SCH 80 Nipple Length (inches)												
In.	Part	CL	1-1/2	2	2-1/2	3	3-1/2	4	4-1/2	5	5-1/2	6
1/4	880	-005	-015	-020	-025	-030	-035	-040	-045	-050	-055	-060
3/8	881	-005	-015	-020	-025	-030	-035	-040	-045	-050	-055	-060
1/2	882	-005	-015	-020	-025	-030	-035	-040	-045	-050	-055	-060
3/4	883	-005	-015	-020	-025	-030	-035	-040	-045	-050	-055	-060
1	884	-005		-020	-025	-030	-035	-040	-045	-050	-055	-060
1-1/2	886	-005		-020	-025	-030	-035	-040	-045	-050	-055	-060
2	887	-005			-025	-030	-035	-040	-045	-050	-055	-060

EPOXY & COATINGS

RAMUC TYPE EP EPOXY

Part No.	Color
908130001	Aquagreen / Gallon
908130301	Dark Blue / Gallon
908131101	White / Gallon
908132101	Black / Gallon
908132801	Dawn Blue / Gallon
912231102	Hi-Build, White / 2 Gal
912232102	Hi-Build, Black / 2 Gal
912232802	Hi-Build, Dawn Blue / 2 Gal



EP EPOXY cures to a hard, tough, durable finish, providing stain, chemical and abrasion resistance for protection of concrete, plaster and fiberglass swimming pools, spas and slides. EP Epoxy cures to a high gloss-finish with excellent coverage rates, especially on previously painted epoxy surfaces. EP

Epoxy has been a proven performer for more than 50 years. Because of their chemical cure, epoxies are the paints of choice for indoor pools. This premium low film build epoxy coating is formulated to provide ease of application and excellent coverage rates. Protects previously painted epoxy or unpainted concrete/plaster/fiberglass/gelcoat swimming pools and spas. Excellent choice for water park facilities, including lazy rivers. High gloss, tile-like finish provides ease of cleaning. Abrasion and chemical-resistant Self-priming Two-coat system. Use SKID-TEX Additive to achieve a non-slip surface. Coverage: 500 sq. ft./gal.

RAMUC TYPE A-2 PREMIUM

Part No.	Color
902132101	Black / Gallon
2962231101	White / Gallon
962232801	Dawn Blue / Gallon



TYPE A2 is an excellent choice to recoat previously painted chlorinated rubber and synthetic rubber painted pools, especially in VOC restricted areas. Coverage: 200-300 sq. ft. on bare surface 300-400 sq. ft. on recoats.

For upgrading & restoring previously painted synthetic or chlorinated rubber painted pools. High gloss finish allows for easy cleaning. Easy to apply by roller or airless spray. Self-priming. Two-coat system. VOC Compliant in US and Canada. Service life up to 4 years. Use Skid-Tex to create a non-slip finish.



PATIO TONES will greatly enhance the beauty of any concrete patio or pool deck. Plain or worn concrete gives a dull and uninteresting appearance, detracting from the ambiance of the area. PATIO TONES adds life as well as protection. PATIO TONES is also excellent for the restoration of sprayed and patterned concrete surfacing systems. Simply make any necessary repairs, clean the deck according to label instructions, and roll on PATIO TONES. The acrylic formula lets you prepare and coat in one day. The result will be a surface that is safe, beautiful and protected. Coverage: 90 - 125 square feet per gallon depending on surface porosity. Available in five-gallon and one-gallon containers. Two coats required on initial application.

OLYMPIC DURACOURT VINYL

Part No.	Color
NO-140-1	White / Gallon
NO-160-1	Tile Red / Gallon
NO-180-1	Green / Gallon



DURACOURT OUTDOOR COURT COATING is an easy to use, one-coat tennis court finish for asphalt and concrete surfaces. This product exhibits outstanding durability and color retention. DURACOURT coatings may also be used to resurface previously coated courts with excellent results. DURACOURT is also perfect for basketball courts or any recreational surface. Colors available are green, tile red and white. Coverage is 100 to 125 sq. ft. per gallon, depending on the porosity of the surface.

OLYMPIC EPOXY & PRIMER



OLYMPIC ZERON EPOXY HEAVY ONE COAT EPOXY

Part No.	Color
NO-390-1	White / Gallon
NO-391-1	Blue Ice / Gallon
NO-392-1	Bikini Blue / Gallon
NO-395-1	Blue Mist / Gallon
NO-399-1	Black / Gallon

THE ZERON SYSTEM is the longest lasting epoxy pool coating available. You can expect up to eight years of service from one application of this product. The greatest advantage of the ZERON system is that it only requires one coat. ZERON is a heavier bodied material than POXOLON 2 so it will require a little more effort in its application and will not spread as far. However, due to the extremely long life of ZERON, the cost per year of service is lower than any other pool coating available.

This coating may be applied by roller or airless spray equipment. ZERON is highly recommended for professional pool builders and pool service companies as an alternative to traditional pool plaster. The finished surface will stay brighter and will be easier to keep clean than a plastered pool. Coverage: Approximately 125 - 150 sq feet per gallon.

POXOPRIME II epoxy primer soaks in and seals uncoated concrete & plaster. Used as an undercoat for Poxolon II and Zeron epoxy. Poxoprime II's compatibility with wet surfaces helps reduce downtime by allowing the pool to be cleaned and primed in one day. Do not apply over old coating. Coverage: 200-250 Square Feet Per Gallon.

OLYMPIC POXOLON EPOXY CONCRETE, PLASTER & METAL POOLS

Part No.	Color
NO-2212-1	Viking Blue / Gallon
NO-2222-1	Viking Blue / Gallon
NO-2226-1	Black / Gallon
NO-2228-1	Bikini Blue / Gallon
NO-2225-1	Blue Ice / Gallon
NO-2231-1	Blue Mist / Gallon

POXOPRIME II epoxy primer soaks in and seals uncoated concrete & plaster. Used as an undercoat for Poxolon II and Zeron epoxy. Poxoprime II's compatibility with wet surfaces helps reduce downtime by allowing the pool to be cleaned and primed in one day. Do not apply over old coating. Coverage: 200-250 Square Feet Per Gallon.

PRIMER

Part No.	Color
NO-214-1	Poxoprime II Epoxy / Gallon
NO-215-1	Bonderite Epoxy / Gallon
NO-216-1	Gunzite Epoxy / Gallon
NO-219-1	Steel Epoxy / Gallon
NO-220-1	Galvanized Steel

BONDERITE primer is specifically formulated for use over bare aluminum pool surfaces. This material is a two-part epoxy that should be applied by roller or spray over sanded aluminum. Two coats are recommended for maximum protection. BONDERITE should be used as an undercoat for POXOLON 2 and ZERON. Coverage: 200 - 250 square feet per gallon.

POXOLON 2 is a high gloss epoxy pool coating that is easy to apply and should yield up to five years of service. This finish is very easy to clean as is the case with all epoxy pool coatings. Use POXOLON 2 on most conventional pool surfaces with excellent results. Uncoated pool surfaces will require a prime coat to insure good adhesion. Recommended for use by pool service companies and the do it yourself pool owner. Use with primer on concrete, plaster, fiberglass and metal pools. Two finish coats of POXOLON 2 are required in all cases. POXOLON 2 may be applied by either airless sprayer or roller. Coverage: Approximately 225 - 250 sq feet per gallon.

GUNZITE is a two-part epoxy primer for application over fiberglass or unusually rough plaster or concrete. The heavy viscosity of GUNZITE acts as a fill coat on concrete and plaster and provides a much smoother surface. GUNZITE should only be used as an undercoat for POXOLON 2 or ZERON. Especially effective on sandblasted surfaces. Coverage: 100 - 150 square feet per gallon.

No. 219 STEEL EPOXY PRIMER is for bare steel pool surfaces. Bare steel must be sandblasted, degreased and primed immediately.

No. 220 GALVANIZED STEEL PRIMER is a special formula primer for galvanized steel surfaces. See label instructions for application. Coverage: 200 - 250 square feet per gallon.

RESURFACING / SOLVENTS / FILLERS

OLYMPIC PARALON 2 PREMIUM CHLORINATED RUBBER COATING



Part No.	Color
NO-290-1	White / Gallon
NO-291-1	Blue Ice / Gallon
NO-292-1	Bikini Blue / Gallon
NO-296-1	Blue Mist / Gallon
NO-297-1	Black / Gallon

PARALON 2 is our premium grade chlorinated rubber base pool enamel. This coating is recommended for refinishing existing chlorinated rubber coatings. It is an attractive, high gloss, rubber-base pool enamel with exemplary chemical resistance. The high gloss appearance will please the most discriminating pool owner while providing economical protection for the pool surface. Two coats of PARALON 2 are required for best results. On unusually porous, bare surfaces like concrete or plaster, a third coat may be necessary. Coverage: 250 - 275 square feet average per gallon.

DIVING BOARD RESURFACING KIT & SOLVENT



Part No.	Color
NO-U100	White / Quart Resurface
NO-U102	Bikini Blue / Quart Resurf
NO-1108-1	Rubber Based / Gallon
NO-1109-1	Epoxy / Gallon

DIVING BOARD RESURFACING KITS provide sure footing to worn out diving boards. Each Diving Board Kit contains one quart of Super Convoy, one pint thinner, one roller cover and complete instructions. This product can be applied to fiberglass, aluminum or wood with excellent results. **SOLVENT & THINNER** for Zeron & Poxolon epoxy. Shipping weight 5.67 Lbs.

ACRYLIC PAINT / SOLVENT / EPOXY

RAMUC TYPE DS WATER-BASED ACRYLIC



This acrylic pool paint is formulated to offer all of the advantages of water-based technology. It can be applied over most previously painted pool surfaces and in damp environments. Coverage: 350-400 sq. ft/gal.

Excellent solution when short down-time is critical
For previously painted rubber or acrylic based coatings
Adheres best on a cool, damp (not wet), and extremely clean surface
Excellent UV protection
Self-Priming, Matte Finish
Use SKID-TEX Additive to achieve non-slip surface
No solvent vapors
Minimal cure time
Cleans up with soap and water
Up to 2 years service life

Part No.	Color
910131101	White / Gallon
910132101	Black / Gallon
910132801	Dawn Blue / Gallon



RAMUC THINNER & CLEANUP 9221000M01

Gallon
Ramuc thinner can be used with Ramuc epoxy or Ramuc rubber based paints.



NO-962-1 POXOFILL EPOXY PUTTY

POXOFILL can be used for permanent patching of concrete for a strong, lasting bond. Also used for anchoring diving boards, ladders and resetting tile. It can be applied with a putty knife, molded by hand, or spackled with a spackling tool or trowel, when holes, depressions, ruts, and cracks in concrete pool surfaces are to be repaired.



NO-260-1 FUSION PLUS PAINT

FUSION PLUS is the smart way to convert your worn rubber-base coated pool to an epoxy finish. Simply clean surface, roll on FUSION PLUS, then follow with one coat of ZERON or two coats of POXOLON. Your rubber to epoxy finish will be beautiful, and will last for years. Coverage: Approximately 225 - 250 square feet per gallon



NO-935-1H EXPANSION JOINT, THERMOLASTIC FILLER

Thermolastic Joint Filler for expansion joints is a permanently flexible, polysulfide rubber-base material for filling horizontal joints in concrete. Preferred application is with a closed type caulking gun for best results but an experienced applicator can apply with a putty knife. Cures tack free in 24 hours, to a resilient solid rubber material within 48 hours and fully cures after 5 to 7 days.



RAMUC ACRYLIC DECK COAT WATER-BASED ACRYLIC

This water-based acrylic deck coating is formulated for upgrading Kool-Deck and other textured concrete deck surfaces.

Coverage: 125-150 sq. ft/gal. bare

Keeps your deck cool while protecting it from harsh UV rays
Formulated to upgrade concrete pool decks, Kool-Deck and other textured deck surfaces
Performs especially well in extremely hot areas of the U.S.
Allows deck to breathe, providing a cool surface
Self priming, flat finish
Up to 2 years service life
VOC Compliant in US and Canada

Part No.	Color
951046301	Dune Shadow / Gallon
951046601	Silver Creek / Gallon
951046901	Cayman Sand
951047101	Whisper White / Gallon



TNEMEC HI-BUILD EPOXOLINE II

N69-00WH
White / 2 Gallon

N69-35GR
Black / 2 Gallon

An advanced generation epoxy for protection and finishing of steel and concrete. It has excellent resistance to abrasion and is suitable for immersion as well as chemical contact exposure
Coverage Rate: 179 SQ FT/Gallon



BOXER VINYL POOL REPAIR KIT 1061

Clear / 4 Ounce Can, 500 sq. in. patch
Deluxe kit features an ample 4 ounce supply of liquid adhesive in a can with screw top and attached dauber-applicator, plus 500 square inches of clear patching vinyl.



ATLAS POOL PUTTY 530318

2-Part Molded Epoxy, White / 14 Ounce Tube Set

Atlas Epoxybond Pool Putty is a unique two-part, hand-moldable epoxy putty specially formulated for concrete or Gunite pool repairs. The convenient cartridge form provides a simple, equal mixing ratio (1 to 1). Just cut, mix and fix. There is no need to drain pools to repair leaks and cracks because Epoxybond Pool Putty hardens underwater. Once cured it will not shrink or sag.

UNDERWATER MAGIC ADHESIVE & SEALANT



Underwater Magic is a 1 component sea and chlorine water resistant glue, which even seals underwater. It is odor free, it's free of: Oxime - acetic acid - isocyanate & solvents, 100% silicone free and is not affected by: chlorine / salt (sea) water, weathering and uv light, Aliphatic solvents, oils, grease, diluted inorganic acids and alkalis.

Part No.	Color
UWM-01C	White / 9.8 Ounce
UWM-02C	Blue / 9.8 Ounce
UWM-03C	Tan / 9.8 Ounce
UWM-04C	Grey / 9.8 Ounce
UWM-09C	Black / 9.8 Ounce

VULKEM SEALANT

1570G
Vulkem 116 One-Part Polyurethane Sealant, Gray / 10.5 Ounce Cartridge



VK-45SSLG
Vulkem 45SSL One-Part Polyurethane Sealant, Gray / 30 Ounce Cartridge

VK116W
Vulkem One-Part Polyurethane Sealant, White / 10 Ounce Cartridge

VK45SSLW
Vulkem 45SSL One-Part Polyurethane Sealant, White / 30 Ounce Cartridge

Part No.	Color
1570G	Gray - 10.5 Ounce
VK-45SSLG	Gray - 30 Ounce
VK116W	White - 10 Ounce
VK45SSLW	White - 30 Ounce
ASI #57	White - Polyurethane



Ruscoe's Permanent Sealer High Viscosity is a versatile minimal flow adhesive, completely resistant to all climatic conditions, fungus and many chemicals, designed particularly for application in bonding aluminum to aluminum or aluminum to other surfaces. While it fills a specific need in the

RUSCOE'S PERMANENT SEALER 1533C-HV

HV, Aluminum / 10.3 Ounce Cartridge

swimming pool, marine and recreational vehicle, mobile home and aluminum storm door industries, it can be used for practically any bonding requirements. Permanent Sealer forms a firm, permanent, yet FLEXIBLE bond which will withstand sub-zero temperatures as well as high temperatures of 165° F.

Issue #7

SPEAR

A LANDMARK AQUATIC
COMPANY

SERVICES

For over 40 years, Spear has been serving the commercial swimming pool industry throughout Indiana, Illinois, Kentucky and Ohio.

AQUATIC SERVICES

Design / Consulting
Swimming Pools & Splash Pad Construction
Mechanical Renovation
CPO Education · Seminars
Technical Support
Maintenance

AQUATIC SALES & SERVICE

Swimming Pool Equipment
LMI Authorized Service Center
Palintest Authorized Service Center
Stenner Pump Authorized Service Center
Maytronics Authorized Service Center
Waste Water Treatment Equipment
Municipal Water Equipment
Pool Mechanical Equipment
Enduro Vac Authorized Service Center

AQUATIC EQUIPMENT

Defender Regenerative Media Filters
BECSys Water Chemistry Controllers
Maytronics Robotic Pool Cleaners
NEX-GEN Chlorine Generators
ETS UV Treatment Systems
Pulsar Chlorine Feeders
Lochinvar Pool Heaters
Palintest Test Kits
Neptune Benson High Rate Sand Filters
Enduro Vac Robotic Pool Cleaners
Clear Flow

12966 N County Road 50 W
Roachdale, Indiana 46172
800.642.6640
info@spearcorp.com
spearcorp.com

